

COLLECTION 2024

CALENDRIERS ET CARNETS / CALENDARS AND NOTEBOOKS



PAPIER DE PIERRE / STONE PAPER



PAPIER D'HERBES / GRASS PAPER



PAPIER RECYCLÉ / RECYCLED PAPER

LES EXEMPLES DE PAPIERS ÉCOLOGIQUES SONT PRÉSENTÉS À LA FIN DU CATALOGUE
MODELS OF ECOLOGICAL PAPERS ARE PRESENTED AT THE END OF THE CATALOGUE

SOMMAIRE / TABLE OF CONTENTS

UN ARBRE POUR UN CALENDRIER / A TREE FOR A CALENDAR	04
PAPIER DE GRAINES / PAPER WITH SEEDS	06
MÉTHODES DE MARQUAGE / DEBOSSING METHODS	08
rPET	14
RE-COVER	16
QUERK	18
NATURA	20
SAVANA	22
GAMBO NEW	24
COLORADO NEW	26
CROSS	28
PIKO	30
METALLIC PRINT	32
GUMA	34
VIVELA	36
CANVAS	38
CANVAS LINE	40
CANVAS - SPINE / HORIZONT	42
KRAFT	44
DURO	45
IMAGE	46
FLESZ	47
IDEO	48
IDEO EXCLUSIVE	50
SET PREMIUM / PREMIUM SETS	52
CARBON	54
ITALIANO	56
PATTES / SYNTHETIC LEATHER TABS	58
CALENDRIER DE BUREAU DEBOUT OU À POSER / LYING AND STANDING DESK CALENDAR	60
EMBALLAGES / PACKAGINGS	62
COMPLÉMENTS / ADD-ONS	64
PROJET PERSONNALISÉ / CUSTOMISED DESIGN	76
MARQUAGE DES COUVERTURE / COVERS MARKING METHODS	77
LISTE DE L'ANNÉE / YEAR DESIGN	78
LIAISON DE COUVERTURE / COVER COMBINATIONS	83
MATRICES GRAND FORMAT / LARGE FORMAT STAMPS	84
MISES EN PAGE DE CALENDRIERS JOURNALIERS / DAILY CALENDARS LAYOUTS	86
MISES EN PAGE DE CALENDRIERS HEBDOMADAIRES / WEEKLY CALENDARS LAYOUTS	90
CARNETS / NOTEBOOKS LAYOUTS	102
GADGETS ECO / ECO GADGETS	104
CÂBLE DE CHARGE USB / USB CHARGING CABLES	116
POWER BANKS / POWERBANKS	120
ENERGY SET	121
POWER SET	124
WHITE BOX & BLACK BOX	126
LISTE DE BLOCS / LIST OF BLOCKS	128



**PLANTEZ
UN ARBRE
AVEC NOUS !**

PLANT
A TREE
WITH US!

**CONTRIBUEZ
À LA PROTECTION
DE L'ENVIRONNEMENT
ET DU DÉVELOPPEMENT
DURABLE**

CONTRIBUTE
TO PROTECTING
THE NATURAL
ENVIRONMENT
AND SUSTAINABLE
DEVELOPMENT

100 CALENDRIERS
CALENDARS = 1 ARBRE
TREE 

GRÂCE AU PROGRAMME **POSADZIMY.PL** POUR CHAQUE 100 CALENDRIER ACHETÉS, NOUS
PLANTERONS 1 ARBRE. / THANKS TO POSADZIMY.PL PROGRAMME, FOR EVERY 100 CALENDARS
PURCHASED FROM US, WE WILL PLANT 1 TREE.

N1
**GRAINES
DE PIN**
PINE SEEDS

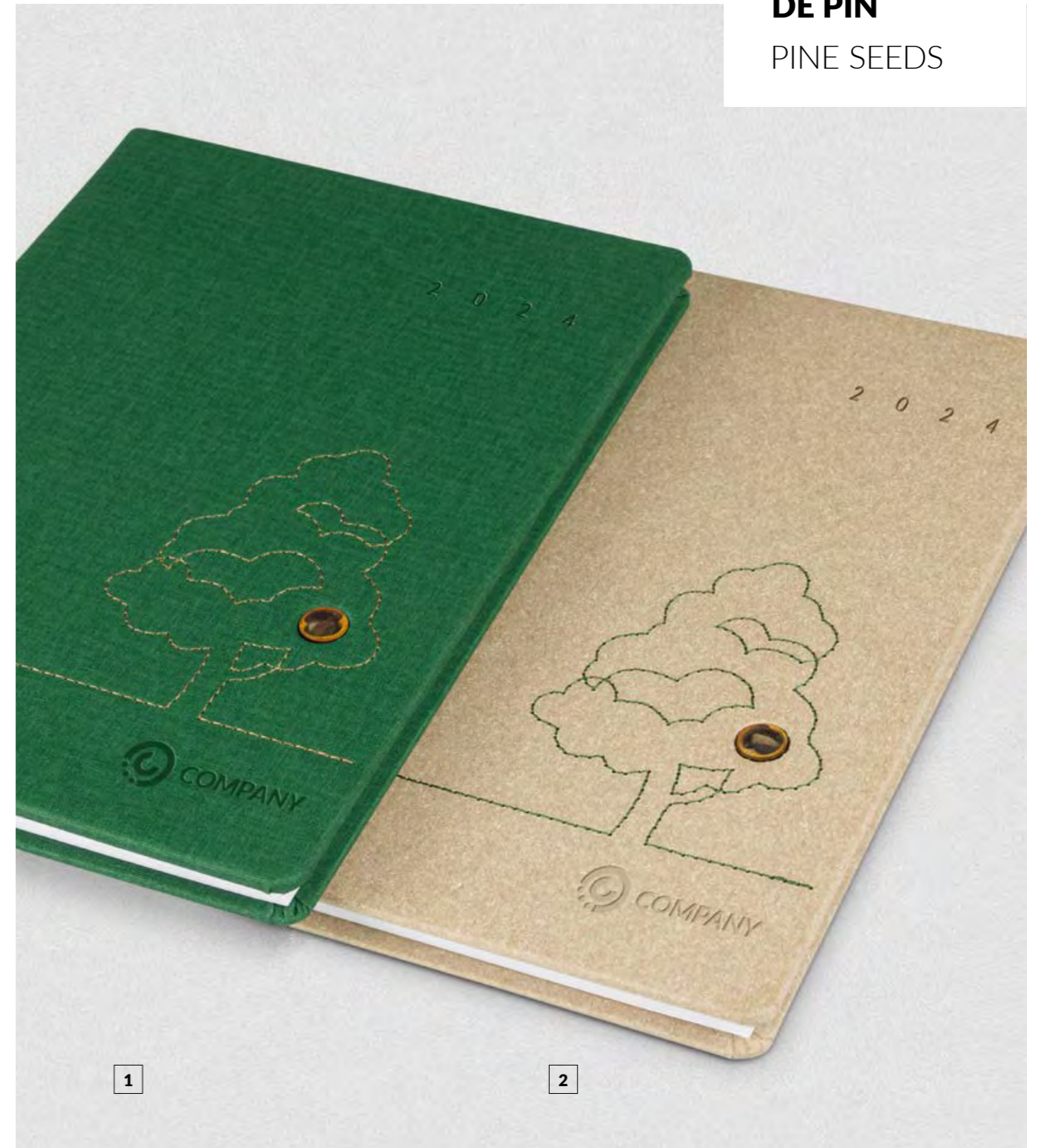

INSPIRATION / INSPIRATION

année / year design 12

couverture / cover [1] - CANVAS, [2] - NATURA

marquage / marking method **embossage, couture créative** / debossing, creative stitching

complément / add-on **N1 NEW**



LE PAPIER DE GRAINES CONTIENT UN MÉLANGE DE FLEURS DES CHAMPS

PAPER WITH SEEDS CONTAINS A MIX OF FIELD FLOWERS

- COQUELICOT / FIELD POPPY
- MARGUERITE / DAISY
- MYOSOTIS / FORGET-ME-NOT
- LYCHNIS / CATCHFLY



PLANTEZ, ARROSEZ ET ENTRETENEZ!

PLANT, WATER, CARE FOR!



insert / insert page

FORME / SHAPES

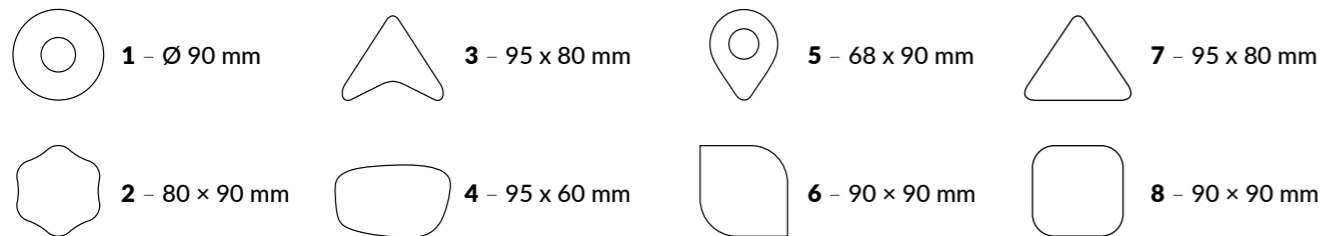

**CRÉEZ VOTRE
PROPRE
COLLECTION**
CREATE YOUR
OWN DESIGN

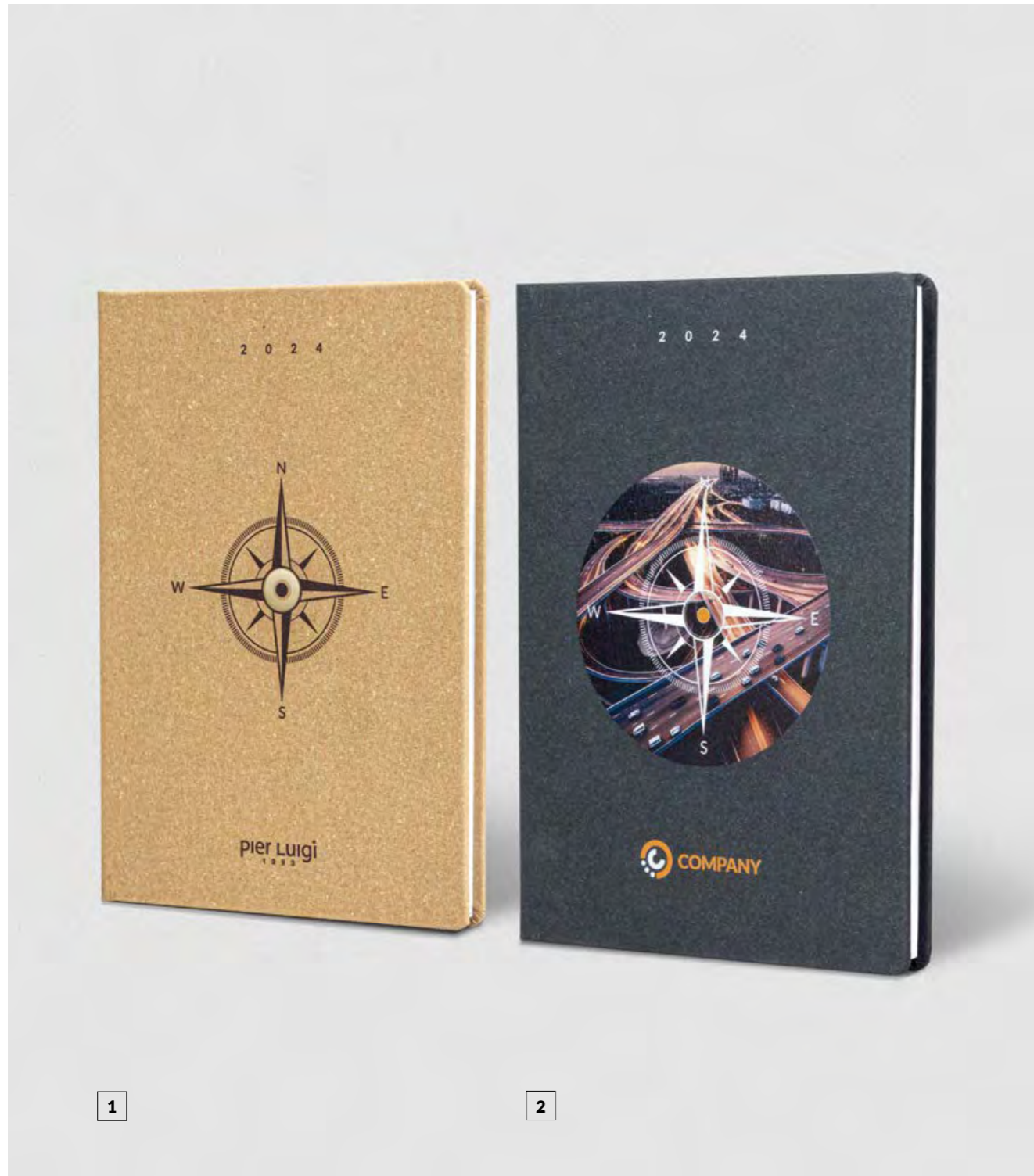

INSPIRATION / INSPIRATION

année / year design imprimé / printed
couverture / cover RE-COVER
marquage / marking method 1 2 - impression / print
complément / add-on 1 - M19

INSPIRATION / INSPIRATION

année / year design 3 - 2B, 4 - imprimé / printed
couverture / cover 3 - IDEO, 4 - GUMA
marquage / marking method 3 - impression embossage / print, debossing, 4 - impression / print
complément / add-on 4 - élément personnalisé 3D / 3D customised element **NEW**



INSPIRATION / INSPIRATION

- année / year design **1** - 20, **2** - B1 **NEW**
- couverture / cover **1** - IDEO, **2** - GAMBO
- marquage / marking method **1** - embossage grand format / large format debossing*
 2 - embossage grand format, couture créative /
 large format debossing*, creative stitching
- complément / add-on **1** - finochrome personnalisé / customised finochrome

*MATRICES GRAND FORMAT POUR EMBOSSES FOURNIES SUR LA PAGE 84. / LARGE FORMAT STAMPS FOR THE DEBOSSING ARE AVAILABLE FROM PAGE 84.

INSPIRATION / INSPIRATION

- année / year design M4
- couverture / cover IDEO
- marquage / marking method embossage créatif grand format, embossage par feuille plastique couture créative /
 customised large format debossing, foil debossing, creative stitching
- complément / add-on M17B



1

2

INSPIRATION / INSPIRATION

année / year design

2 - 7

couverture / cover

1 - IDEO, 2 - CROSS

marquage / marking method

1 - couture créative **LINE 2**, embossage, gravure /
creative stitching **LINE 2**, debossing, engraving
2 - couture, embossage, gravure / stitching, debossing, engraving

complément / add-on

1 - M21, 2 - M11



3

4

INSPIRATION / INSPIRATION

année / year design

3 - M3, 4 - 2B

couverture / cover

GUMA

marquage / marking method

4 - embossage gravure / debossing, engraving

complément / add-on

3 - bande élastique horizontale plate 10 mm / 10 mm horizontal elastic band
4 - bande élastique verticale plate 10 mm + M15, + boucle pour stylo /
10 mm vertical elastic band + M15, elastic pen holder

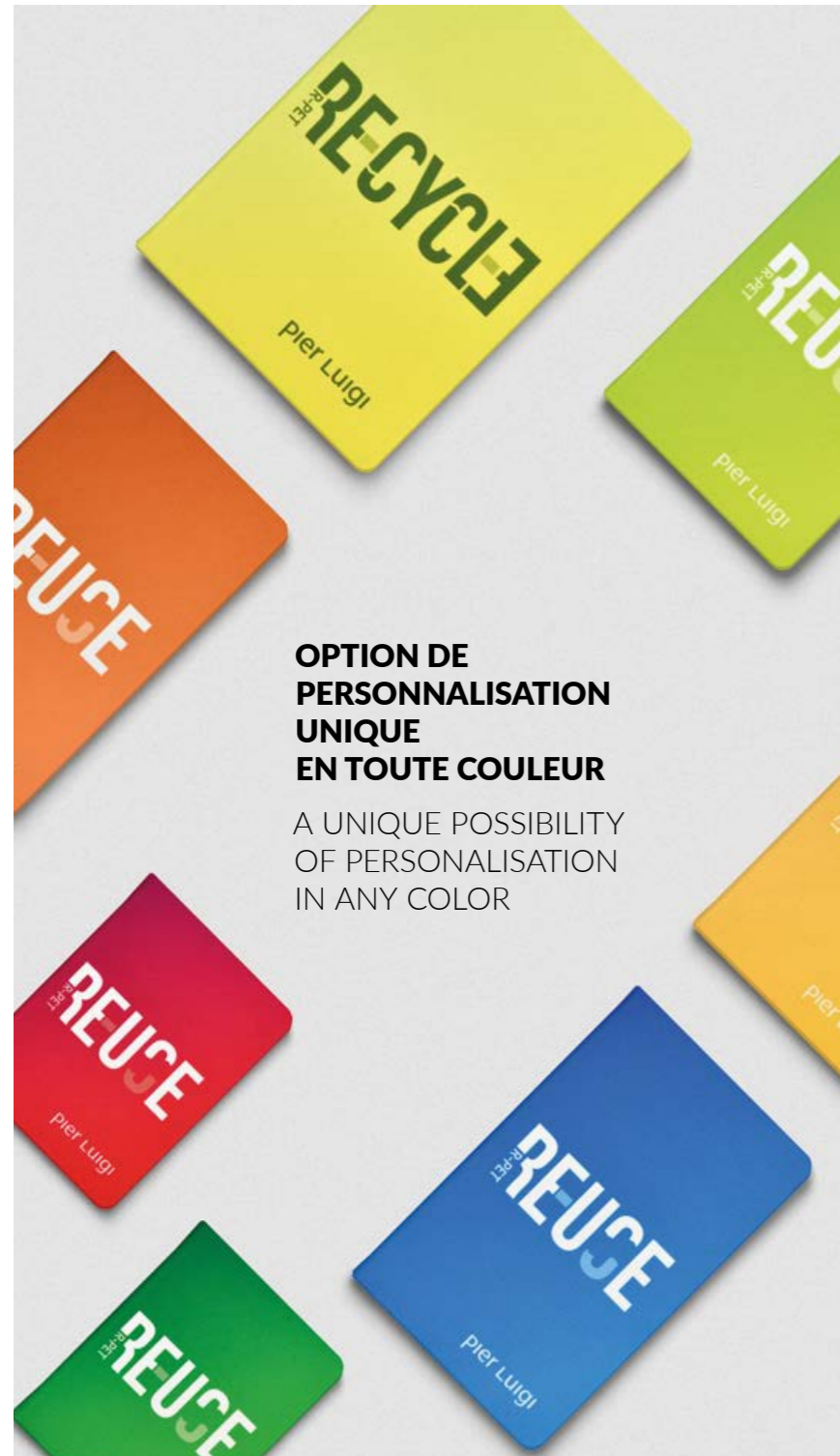

OPTION DE PERSONNALISATION UNIQUE EN TOUTE COULEUR

A UNIQUE POSSIBILITY OF PERSONALISATION IN ANY COLOR

IMPRESSION PAR SUBLIMATION / SUBLIMATION PRINTING



rPET

année / year design

imprimé / printed

couleur / colour

blanc / white



rPET IMPRESSION PAR SUBLIMATION
SUBLIMATION PRINTING



rPET

CHOISISSEZ VOTRE CALENDRIER OU CARNET AVEC UN BLOC EN PAPIER RECYCLÉ (~A5, ~B5), POUR PROFITER À 100 % D'UN PRODUIT ÉCOLOGIQUE CONÇU À PARTIR DE MATIÈRES PREMIÈRES RÉCUPÉRÉES.

CHOOSE YOUR CALENDAR OR NOTEBOOK WITH A BLOCK OF RECYCLED PAPER (~A5, ~B5), TO ENJOY A 100% ECOLOGICAL PRODUCT MADE OF RECYCLED RAW MATERIALS.

Le **rPET** est un matériau **RECYCLÉ** obtenu à 100 % à partir de déchets de consommation, le plus souvent de bouteilles de type PET. Pour 1 m² nous utilisons 12 bouteilles de 1,5 litres. Le matériau recyclé est conçu pour une impression par sublimation – CMYK.

rPET is a **RECYCLING** material obtained in 100% from post-consumer waste, most often from PET bottles. 12 bottles of 1.5 liters are used per 1 m². Recycling material intended for sublimation printing – CMYK.

MARQUAGE DE COUVERTURES DÉDIÉ MISES EN PAGE DES CALENDRIERS ET DES CARNETS SONT FOURNIS DE LA PAGE 77. / DEDICATED MARKING METHODS OF COVERS, LAYOUTS OF CALENDARS AND NOTEBOOKS ARE AVAILABLE FROM PAGE 77.

INSPIRATION / INSPIRATION

année / year design

couverture / cover

marquage / marking method

imprimé / printed

rPET

impression par sublimation / sublimation printing

RE-COVER



RE-COVER

année / year design

imprimé / printed

couleur / colour

beige / beige

graphite / graphite **NEW**

brique / brick **NEW**

La couverture **RE-COVER** est un matériau obtenu dans le processus de **recyclage** à partir de cuirs naturels. Elle est entièrement conforme au règlement REACH et à la Convention CITES de Washington. Les paramètres de résistance sont déterminés selon la méthode EN ISO 3376:2011.

New cover called **RE-COVER** is a raw material obtained in the process of **recycling** natural leather. They are fully compliant with the REACH regulation and the Washington CITES Convention. The strength parameters are determined by the EN ISO 3376:2011 method.



INSPIRATION / INSPIRATION

année / year design

imprimé / printed

couverture / cover

RE-COVER

marquage / marking method

impression / print

LES MARQUAGES DE COUVERTURES DÉDIÉS, LES MISES EN PAGE DES CALENDRIERS ET LES CARNETS SE TROUVENT À PARTIR DE LA PAGE 77. / DEDICATED MARKING METHODS OF COVERS, LAYOUTS OF CALENDARS AND NOTEBOOKS ARE AVAILABLE FROM PAGE 77.

INSPIRATION / INSPIRATION

année / year design

imprimé / printed

couverture / cover

RE-COVER

marquage / marking method

impression / print

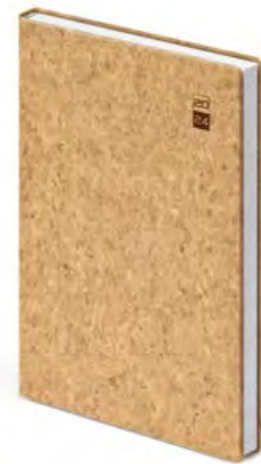
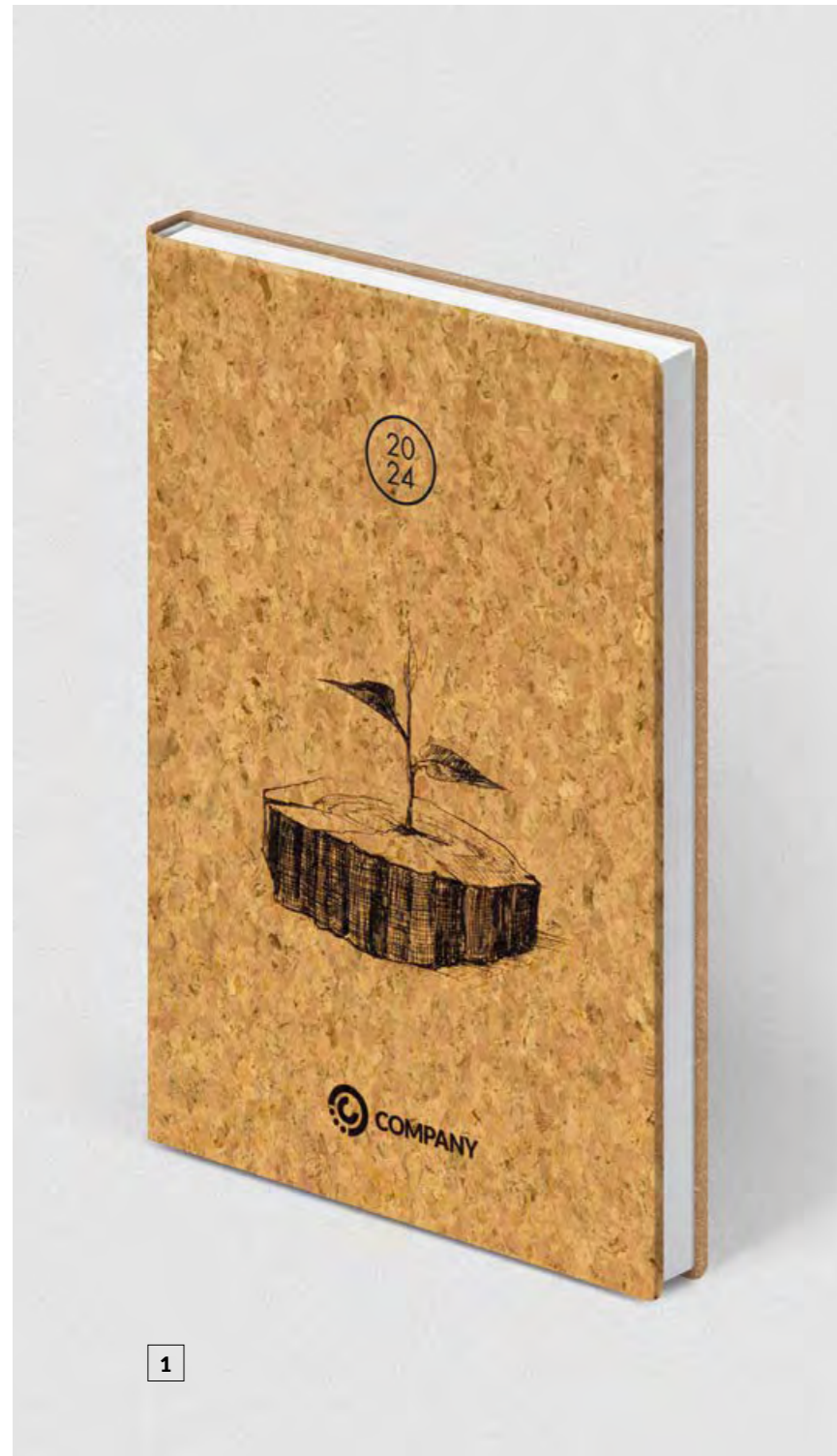

QUERK

année / year design

imprimé / printed

couleur / colour

beige / beige

Le liège est un matériau naturel obtenu à partir de l'écorce de chêne-liège. C'est un matériau entièrement écologique, et végétarien. Il n'y a pas de fragments identiques, ce qui le rend unique.

Cork is a natural material obtained from the bark of the Quercus Suber. It is a fully ecological material and, additionally, vegan. There are no two identical pieces, which makes this material unique.

INSPIRATION / INSPIRATION

année / year design

imprimé / printed

couverture / cover

QUERK

marquage / marking method

impression / print

LES MARQUAGES DE COUVERTURES DÉDIÉES, LES MISES EN PAGE DES CALENDRIERS ET LES CARNETS SE TROUVENT À PARTIR DE LA PAGE 77. / DEDICATED MARKING METHODS OF COVERS, LAYOUTS OF CALENDARS AND NOTEBOOKS ARE AVAILABLE FROM PAGE 77.

**VEILLEZ
À L'ÉCOLOGIE**

TAKE CARE
OF THE
ENVIRONMENT



INSPIRATION / INSPIRATION

année / year design

imprimé / printed

couverture / cover

QUERK

marquage / marking method

impression / print

complément / add-on

[2] - gomme à effacer / spine elastic, G0072 ^{NEW} - stylos / pen, [3] - M16

NATURA



NATURA

année / year design

18

couleur / colour

- beige / beige
- bleu marine / dark blue
- graphite / graphite
- gris / grey **NEW**

COUVERTURE NATURA CERTIFIÉE FSC, QUI VEILLE SUR LES FORÊTS ET SUR L'AVENIR DE NOTRE PLANÈTE.

NATURA COVER WITH THE FSC CERTIFICATE, WHICH CARES FOR FORESTS AND THE FUTURE OF OUR PLANET.

LES MARQUAGES DE COUVERTURES DÉDIÉES, LES MISES EN PAGE DES CALENDRIERS ET LES CARNETS SE TROUVENT À PARTIR DE LA PAGE 77. / DEDICATED MARKING METHODS OF COVERS, LAYOUTS OF CALENDARS AND NOTEBOOKS ARE AVAILABLE FROM PAGE 77.

**IMPRESSION
PATTERN
EN COULEUR
UNIQUE**

ONE COLOUR
PATTERN
PRINTING



1



2



3



4

INSPIRATION / INSPIRATION

année / year design

couverture / cover

marquage / marking method

imprimé sur le dos de la couverture / printed on the spine of the cover

NATURA

impression / print

SAVANA



SAVANA

année / year design

22

couleur / colour

beige / beige

graphite / graphite

gris / grey

bleu marine / dark blue

COUVERTURE 100 % ÉCOLOGIQUE **SAVANA** - PROVENANT DE FORÊTS GÉRÉES SELON LES PRINCIPES DU DÉVELOPPEMENT DURABLE.

100% ECOLOGICAL **SAVANA** COVER - COMING FROM FORESTS MANAGED IN ACCORDANCE WITH THE PRINCIPLES OF SUSTAINABLE DEVELOPMENT.

LE MARQUAGE DES COUVERTURES DÉDIÉES, LES MISES EN PAGE DES CALENDRIERS ET LES CARNETS SE TROUVENT À PARTIR DE LA PAGE 77. / DEDICATED MARKING METHODS OF COVERS, LAYOUTS OF CALENDARS AND NOTEBOOKS ARE AVAILABLE FROM PAGE 77.



INSPIRATION / INSPIRATION

année / year design

16B

couverture / cover

SAVANA

marquage / marking method

embossage, couture créative / debossing, creative stitching



GAMBO

année / year design

20

couleur / colour

- vert / green **NEW**
- marron / brown **NEW**
- gris / grey **NEW**
- noir / black **NEW**

B1 POINTE DE BAMBOU / BAMBOO CIRCLE

LA POSSIBILITÉ DE MARQUER LE CALENDRIER AVEC UN ÉLÉMENT EN BAMBOU À TEXTURE **3D** CONFÈRE AU PRODUIT UN CARACTÈRE UNIQUE.

THE POSSIBILITY OF MARKING THE CALENDAR WITH A BAMBOO ELEMENT WITH A **3D** STRUCTURE GIVES THE PRODUCT A UNIQUE CHARACTER.

LES MARQUAGES DE COUVERTURES DÉDIÉES, LES MISES EN PAGE DES CALENDRIERS ET LES CARNETS SE TROUVENT À PARTIR DE LA PAGE 77. / DEDICATED MARKING METHODS OF COVERS, LAYOUTS OF CALENDARS AND NOTEBOOKS ARE AVAILABLE FROM PAGE 77.

B1 **NEW**
AJOUTEZ
UN ÉLÉMENT
EN BAMBOU

ADD A BAMBOO
ELEMENT



INSPIRATION / INSPIRATION

année / year design

B1 **NEW**

couverture / cover

GAMBO

marquage / marking method

- 1** – embossage, couture verticale / debossing, vertical stitching
- 2** – embossage grand format / large format debossing

complément / add-on

- 1** – cordelette pour / elastic pen holder, **G0073** **NEW** – stylo / pen



COLORADO

année / year design

19A

couleur / colour

bordeaux / maroon **NEW**

noir / black **NEW**

bleu marine / dark blue **NEW**

chocolat / chocolate **NEW**



INSPIRATION / INSPIRATION

année / year design

4A

couverture / cover

COLORADO

marquage / marking method

embossage, couture créative / debossing, creative stitching

CROSS



CROSS

année / year design

6

couleur / colour

rouge / red

bleu marine / dark blue

noir / black

gris / grey

vert / green

orange / orange **NEW**

M16 MORAILLON EN MÉTAL METAL HASP

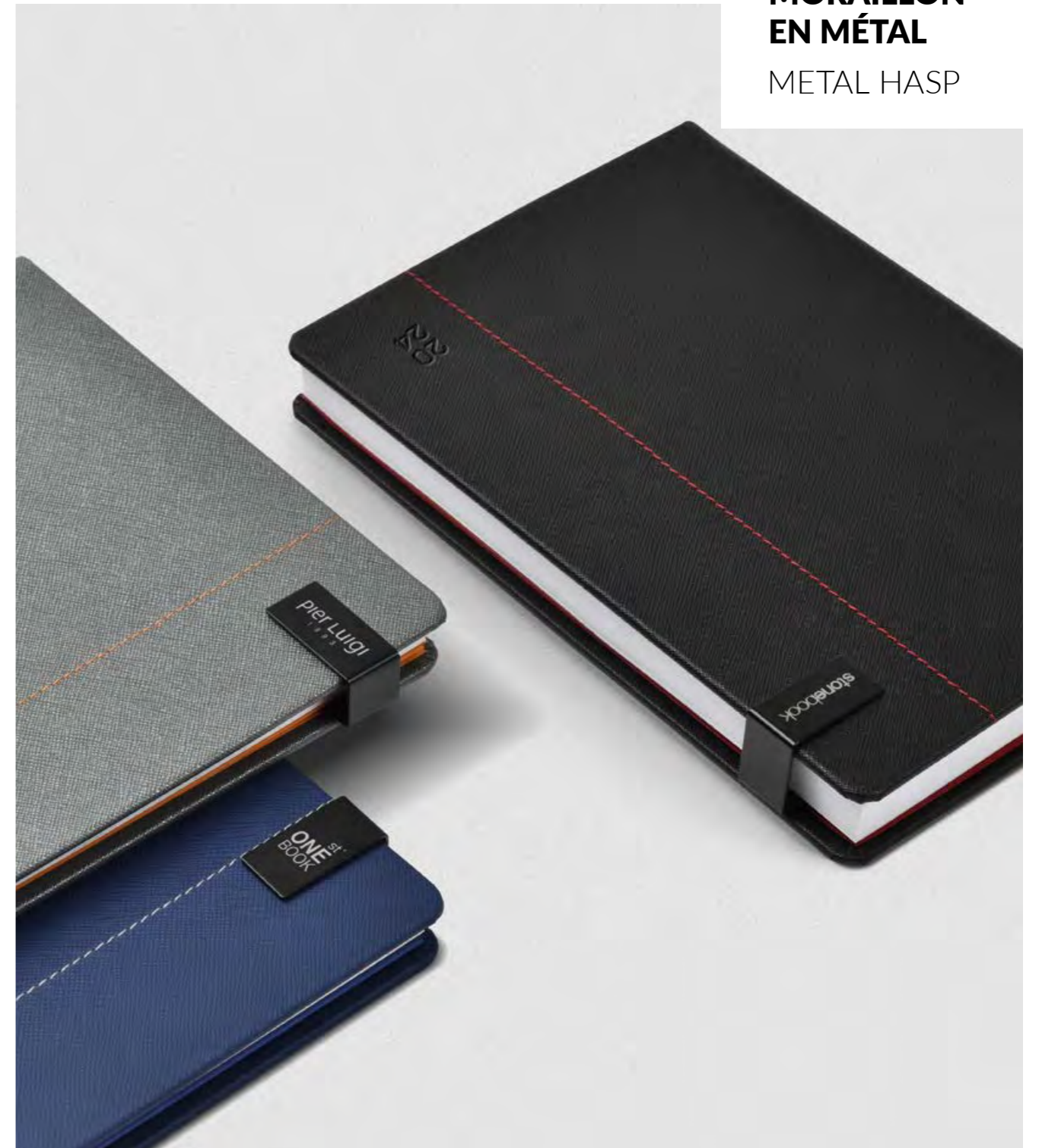

INSPIRATION / INSPIRATION

année / year design

7

couverture / cover

CROSS

marquage / marking method

gravure, couture verticale / engraving, vertical stitching

complément / add-on

M16 + enveloppe / M16 + envelope*

LES MARQUAGES DE COUVERTURES DÉDIÉES, LES MISES EN PAGE DES CALENDRIERS ET LES CARNETS SE TROUVENT À PARTIR DE LA PAGE 77. / DEDICATED MARKING METHODS OF COVERS, LAYOUTS OF CALENDARS AND NOTEBOOKS ARE AVAILABLE FROM PAGE 77.

*M16 NON DISPONIBLE POUR LE FORMAT 504T ET BLOC EN PAPIER D'HERBE. / M16 NOT AVAILABLE FOR 504T OR GRASS PAPER BLOCKS.

PIKO



PIKO

année / year design

2B

couleur / colour

gris / grey

noir / black

bleu marine mat / dark blue matte

bleu marine brillant / dark blue shiny

marron / brown

LES MARQUAGES DES COUVERTURES DÉDIÉES , LES MISES EN PAGE DES CALENDRIERS ET LES CARNETS SE TROUVENT À PARTIR DE LA PAGE 77. / DEDICATED MARKING METHODS OF COVERS, LAYOUTS OF CALENDARS AND NOTEBOOKS ARE AVAILABLE FROM PAGE 77.



INSPIRATION / INSPIRATION

année / year design

1 - M4, 2 - 17A

couverture / cover

PIKO

marquage / marking method

2 - embossage / debossing

complément / add-on

1 - bande élastique verticale plate 10 mm / 10 mm flat elastic band

METALLIC PRINT



2



3



1

INSPIRATION / INSPIRATION

dimension / size

couverture / cover*

finition de couverture / cover finishing

finition / finishing

tirage / print run

pour tout format / for any format

papier / paper

feuillelet plastique: soft touch / foil: soft touch

METALLIC PRINT –
doré, argenté, hologramme / gold, silver, hologram

min. 200 pcs. / MOQ 200 pcs.

*BORD DE COUVERTURE EN PAPIER, UNIQUEMENT DES BORDS DROITS SUR UN CARTON DUR. / PAPER COVER CORNERS, ONLY STRAIGHT CORNERS.

**UN FEUILLET
EN PLASTIQUE
STANDARD
CE N'EST PAS ASSEZ**

STANDARD FOIL
IS NOT ENOUGH
ANYMORE



4



GUMA



IMPRESSION UV / UV PRINT

GUMA

année / year design

10

couleur / colour

noir / black

gris / grey

bleu marine / dark blue

rouge / red

blanc / white

LES MARQUAGES DES COUVERTURES DÉDIÉES , LES MISES EN PAGE DES CALENDRIERS ET LES CARNETS SE TROUVENT À PARTIR DE LA PAGE 77. / DEDICATED MARKING METHODS OF COVERS, LAYOUTS OF CALENDARS AND NOTEBOOKS ARE AVAILABLE FROM PAGE 77.

**QUALITÉ
SUPÉRIEURE
SUR LE MARCHÉ
EN PLEINE
COULEUR**

HIGHEST
QUALITY PRINTING
IN FULL COLOUR



INSPIRATION / INSPIRATION

année / year design

imprimé / printed

couverture / cover

GUMA

marquage / marking method

impression UV / UV PRINT

VIVELA



VIVELA

année / year design

14

couleur / colour

- noir / black
- gris / grey
- bleu / blue **NEW**
- bleu marine / dark blue
- vert / green
- turquoise / turquoise
- rouge / red
- magenta / magenta
- orange / orange
- jaune / yellow
- beige / beige **NEW**

**M15
METAL
TENDANCE**

METAL
IN TRENDS



INSPIRATION / INSPIRATION

année / year design

12

couverture / cover

VIVELA

marquage / marking method

gravure / engraving

complément / add-on

bande élastique verticale plate 10 mm + M15 / 10 mm vertical elastic band + M15



LES MARQUAGES DE COUVERTURES DÉDIÉES, LES MISES EN PAGE DES CALENDRIERS ET LES CARNETS SE TROUVENT À PARTIR DE LA PAGE 77. / DEDICATED MARKING METHODS OF COVERS, LAYOUTS OF CALENDARS AND NOTEBOOKS ARE AVAILABLE FROM PAGE 77.



1

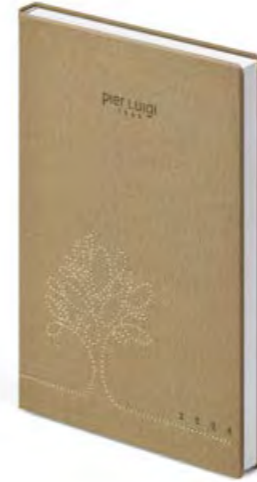

2



IMPRESSION UV / UV PRINT

◀ **CANVAS**

année / year design

20A

couleur / colour

- rouge / red
- vert / green
- bleu / blue
- bleu marine / dark blue
- beige / beige
- marron / brown
- gris / grey
- noir / black
- blanc / white

**COUTURE
CRÉATIVE**
CRÉATIVE
STITCHING



3

POSSIBILITÉ DE METTRE EN PLACE DES MOTIFS POUR CADEAUX OU BRODER LA COUVERTURE SELON UN PROJET PERSONNALISÉ. / POSSIBILITY TO USE THE PRESENTED PATTERNS OR EMBROIDER THE FRAME ACCORDING TO A CUSTOMISED DESIGN.

INSPIRATION / INSPIRATION

année / year design

1 2 - imprimé / printed, 3 - 20B

couverture / cover

CANVAS

marquage /
marking method

- 1 - impression, couture créative /
print, creative stitching
- 2 - embossage, couture créative /
debossing, creative stitching
- 3 - impression, embossage, couture créative /
print, debossing, creative stitching

projet / design

couleur de couverture et de fils au choix /
cover colours and sewing threads to choose

complément / add-on

3 - ruban de sublimation / sublimation ribbon

CANVAS LINE



LINE 1



LINE 2



LINE 3

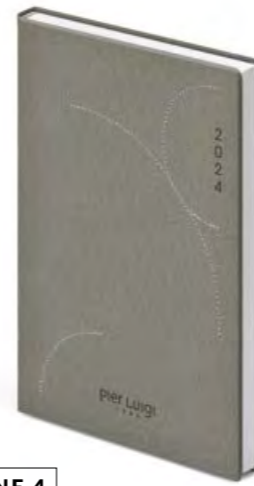

LINE 4



LINE 5 NEW



LINE 6 NEW



INSPIRATION / INSPIRATION

année / year design

LINE 1 LINE 2 - 12, LINE 3 - 7, LINE 4 - 9, LINE 5 - 16A, LINE 6 - 21A

couverture / cover

CANVAS

marquage / marking method

embossage, couture créative / debossing, creative stitching

projet / design

couleur de couverture et de fils au choix / cover colours and sewing threads to choose

LES MARQUAGES DE COUVERTURES DÉDIÉES, LES MISES EN PAGE DES CALENDRIERS ET LES CARNETS SE TROUVENT À PARTIR DE LA PAGE 77. / DEDICATED MARKING METHODS OF COVERS, LAYOUTS OF CALENDARS AND NOTEBOOKS ARE AVAILABLE FROM PAGE 77.



1



2



3



4

CAI

année / year design

couverture / cover

liaison de couverture / cover combinations*

marquage / marking method

projet / design

2B

CANVAS + CANVAS

1 3 5 - 10 SPINE, 2 4 - 28 HORIZONT

impression UV, embossage / UV print, debossing

couleur de couverture et de fils au choix /
cover colours and sewing threads to choose

*S'APPLIQUE UNIQUEMENT AUX COUVERTURES CANVAS - SPINE / HORIZONT UNIQUEMENT SUR UN CARTON DUR. / CONNECTING THE CANVAS COVER MATERIAL - SPINE / HORIZONT ONLY ON HARD CARDBOARD.



2

5

KRAFT



KRAFT

année / year design

M4

couleur / colour

bleu marine / dark blue
graphite / graphite

DURO



DURO

année / year design

3

couleur / colour

gris / grey
noir / black



INSPIRATION / INSPIRATION

année / year design

10B

couverture / cover

KRAFT

marquage / marking method

embossage, couture créative / debossing, creative stitching

complément / add-on

M17B

projet / design

couleur de couverture et de fils au choix / cover colours and sewing threads to choose

LES MARQUAGES DE COUVERTURES DÉDIÉES, LES MISES EN PAGE DES CALENDRIERS ET LES CARNETS SE TROUVENT À PARTIR DE LA PAGE 77. / DEDICATED MARKING METHODS OF COVERS, LAYOUTS OF CALENDARS AND NOTEBOOKS ARE AVAILABLE FROM PAGE 77.

DURO DUO - INSPIRATION / INSPIRATION

année / year design

M3

couverture / cover

DURO + GUMA

liaison de couverture / cover combinations*

11

marquage / marking method

embossage / debossing

complément / add-on

finochrome personnalisé / customised finochrome

LES MARQUAGES DE COUVERTURES DÉDIÉES, LES MISES EN PAGE DES CALENDRIERS ET LES CARNETS SE TROUVENT À PARTIR DE LA PAGE 77. / DEDICATED MARKING METHODS OF COVERS, LAYOUTS OF CALENDARS AND NOTEBOOKS ARE AVAILABLE FROM PAGE 77.

*SÉLECTION DE LIAISONS DISPONIBLES SUR LA PAGE 83. / SELECTION OF AVAILABLE TEMPLATES CONNECTIONS FOR COVERS ON THE PAGE 83.

IMAGE



IMAGE

année / year design

17A

couleur / colour

noir / black
bleu marine / dark blue
graphite / graphite **NEW**

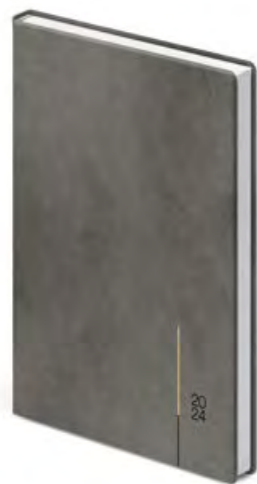
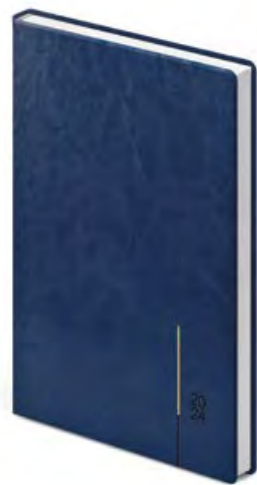

INSPIRATION / INSPIRATION

année / year design

7

couverture / cover

IMAGE

marquage / marking method

gravure / engraving

complément / design*

M8 - 32 GB

*HORS FORMAT 504T. / DOES NOT APPLY TO BLOCK 504T.

FLESZ



FLESZ

année / year design

21

couleur / colour

argenté / silver
doré / gold

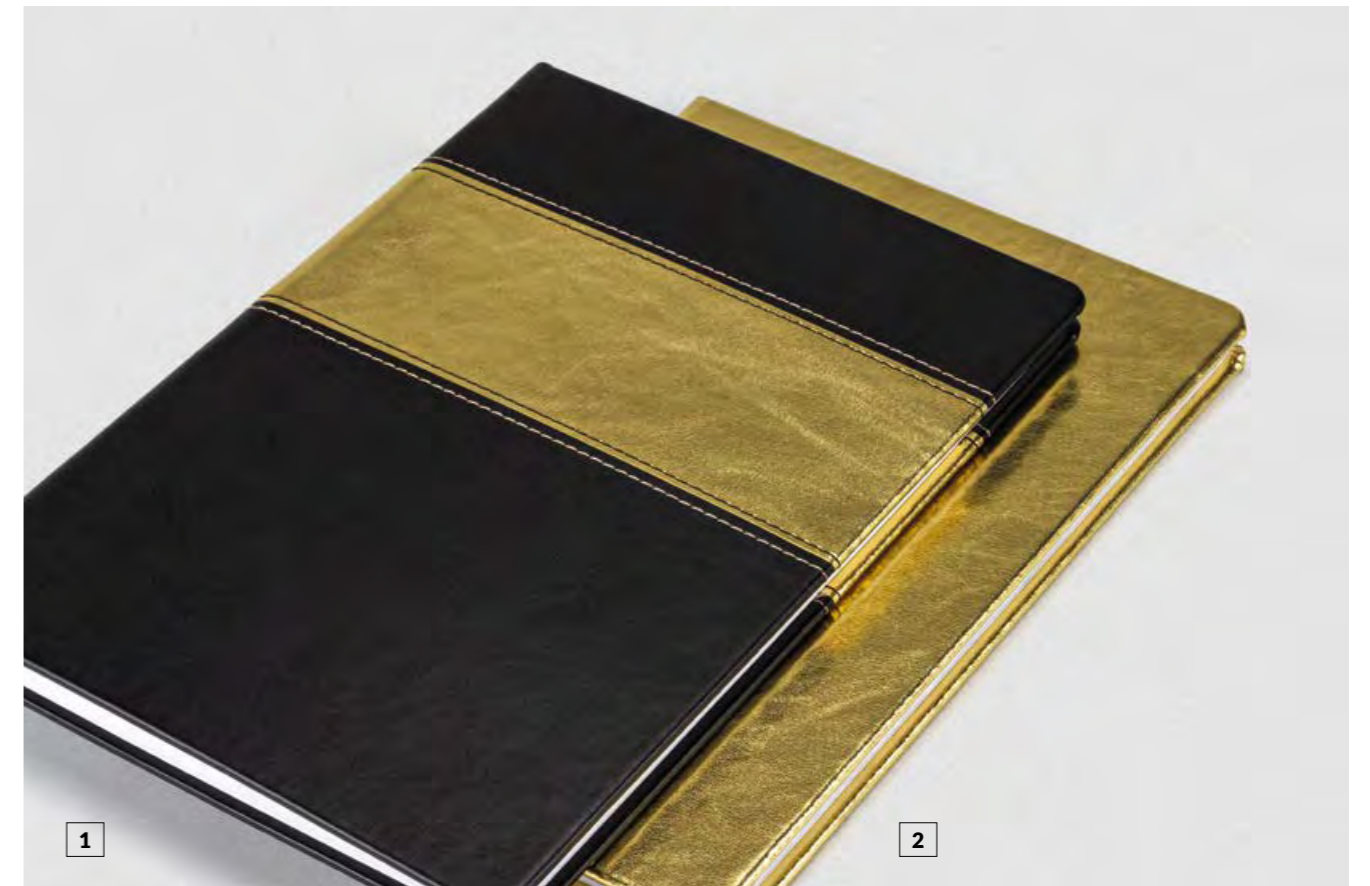

INSPIRATION / INSPIRATION

année / year design

9 - sur le dos de couverture / on the spine of the cover

couverture / cover

1 - IDEO + FLESZ, 2 - FLESZ

liaison de couverture / cover combinations*

1 - 29

projet / design

1 - couleur de couverture et de fils au choix / cover colours and sewing threads to choose

LES MARQUAGES DE COUVERTURES DÉDIÉES, LES MISES EN PAGE DES CALENDRIERS ET LES CARNETS SE TROUVENT À PARTIR DE LA PAGE 77. / DEDICATED MARKING METHODS OF COVERS, LAYOUTS OF CALENDARS AND NOTEBOOKS ARE AVAILABLE FROM PAGE 77.

*SÉLECTION DE LIAISONS DISPONIBLES SUR LA PAGE 83. / SELECTION OF AVAILABLE TEMPLATES CONNECTIONS FOR COVERS ON THE PAGE 83.

IDEO

IMPRESSION UV / UV PRINT



IDEO

année / year design

16A

couleur / colour

blanc / white

céladon / willow-green

rouge / red

bleu marine / dark blue

noir / black

gris / grey

marron clair / light brown **NEW**

bordeaux / maroon **NEW**

**SOULIGNEZ
VOTRE STYLE**

EXPRESS
YOUR STYLE



1

2

INSPIRATION / INSPIRATION

année / year design

1 - 20A, 2 - 23A

couverture / cover

IDEO

marquage / marking method

embossage / debossing

LES MARQUAGES DES COUVERTURES DÉDIÉES, LES MISES EN PAGE DES CALENDRIERS ET LES CARNETS SE TROUVENT À PARTIR DE LA PAGE 77. / DEDICATED MARKING METHODS OF COVERS, LAYOUTS OF CALENDARS AND NOTEBOOKS ARE AVAILABLE FROM PAGE 77.

IDEO EXCLUSIVE



CHEVRON



HILLS



CARO

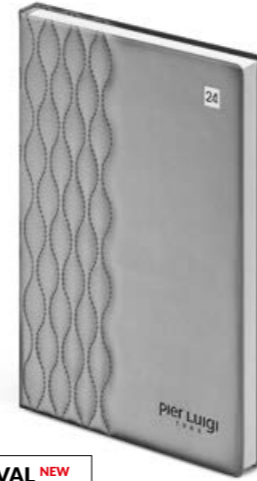

OVAL **NEW**



VENUS



SQUARES



CRYSTALS **NEW**



CHART **NEW**



MODERN



VICTORY



DUNES **NEW**



IDEO EXCLUSIVE

année / year design

couverture / cover

marquage / marking method

projet / design

M4

IDEO

embossage, couture créative / debossing, creative stitching

couleur de couverture et de fils au choix / cover colours and sewing threads to choose



PREMIUM CARO

calendrier en papier de pierre / stone paper calendar

511T / 512T / 516 / 509T

année / year design

M4

couverture / cover

IDEO

marquage / marking method

couture créative, 6 cristaux Swarovski / creative stitching, 6 Swarovski crystals

emballage / packaging

papier teint dans la masse noir avec embossage, papier-calque avec le logo de l'entreprise / black mass dyed paper with debossing, tracing paper with company logo

autres / other

page de garde en papier teint dans la masse / mass dyed endpaper



PREMIUM LOCK

calendrier en papier de pierre / stone paper calendar

511T / 512T / 516 / 509T

année / year design

9 – sur le dos de couverture / on the spine of the cover

couverture / cover

IDEO

marquage / marking method

gravure, couture / engraving, stitching

complément / add-on

M11

emballage / packaging

papier teint dans la masse noir avec embossage argentés, papier-calque avec le logo de l'entreprise / black mass dyed paper with silver debossing, tracing paper with company logo

autres / other

page de garde en papier teint dans la masse noir avec un logo embossé argenté – matrice commune avec l'emballage / silver debossed logo on the both: the black mass dyed endpaper and the packaging

CARBON



CARBON

année / year design

M3

couleur / colour

bleu marine / dark blue

noir / black

gris / grey



1

2

3

PRESTO - INSPIRATION / INSPIRATION

année / year design

1 4 - M2, 2 5 - 9 - sur le dos de couverture / on the spine of the cover,
3 - M3

couverture / cover

CARBON + VIVELA

liaison de couverture / cover combinations*

21

marquage / marking method

1 2 4 5 - gravure / engraving

LES MARQUAGES DE COUVERTURES DÉDIÉES, LES MISES EN PAGE DES CALENDRIERS ET LES CARNETS SE TROUVENT À PARTIR DE LA PAGE 77. / DEDICATED MARKING METHODS OF COVERS, LAYOUTS OF CALENDARS AND NOTEBOOKS ARE AVAILABLE FROM PAGE 77.

*SÉLECTION DE LIAISONS DISPONIBLES SUR LA PAGE 83. / SELECTION OF AVAILABLE TEMPLATES CONNECTIONS FOR COVERS ON THE PAGE 83.

M1/M2
UN ÉLÉMENT
EN MÉTAL
PEUT FAIRE
BEAUCOUP...

METAL
ELEMENT
HAS SO MUCH
POTENTIAL...



4

5

ITALIANO



ITALIANO

année / year design

18

couleur / colour*

bleu marine / dark blue

marron / brown

noir / black



*LA COULEUR VARIÉE DE CUIR ET LES PLIS SONT DES ÉLÉMENTS NATURELS QUI CONTRIBUENT À SON ASPECT UNIQUE. CES ÉLÉMENTS NE SONT PAS COUVERTS PAR UNE GARANTIE. / THE VARIOUS COLOURS OF THE SKIN AND THE FOLDS ON IT ARE ITS NATURAL ELEMENTS AND DETERMINE ITS UNIQUE APPEARANCE. THESE ELEMENTS ARE NOT SUBJECT TO COMPLAINT.

CUIR NATUREL CLASSIQUE ET INTEMPOREL

NATURAL LEATHER
THE LASTING
CLASSIC



INSPIRATION / INSPIRATION

année / year design 18

couverture / cover ITALIANO

marquage / marking method embossage, couture / debossing, stitching

complément / add-on M20A

LES MARQUAGES DE COUVERTURES DÉDIÉES, LES MISES EN PAGE DES CALENDRIERS ET LES CARNETS SE TROUVENT À PARTIR DE LA PAGE 77. / DEDICATED MARKING METHODS OF COVERS, LAYOUTS OF CALENDARS AND NOTEBOOKS ARE AVAILABLE FROM PAGE 77.

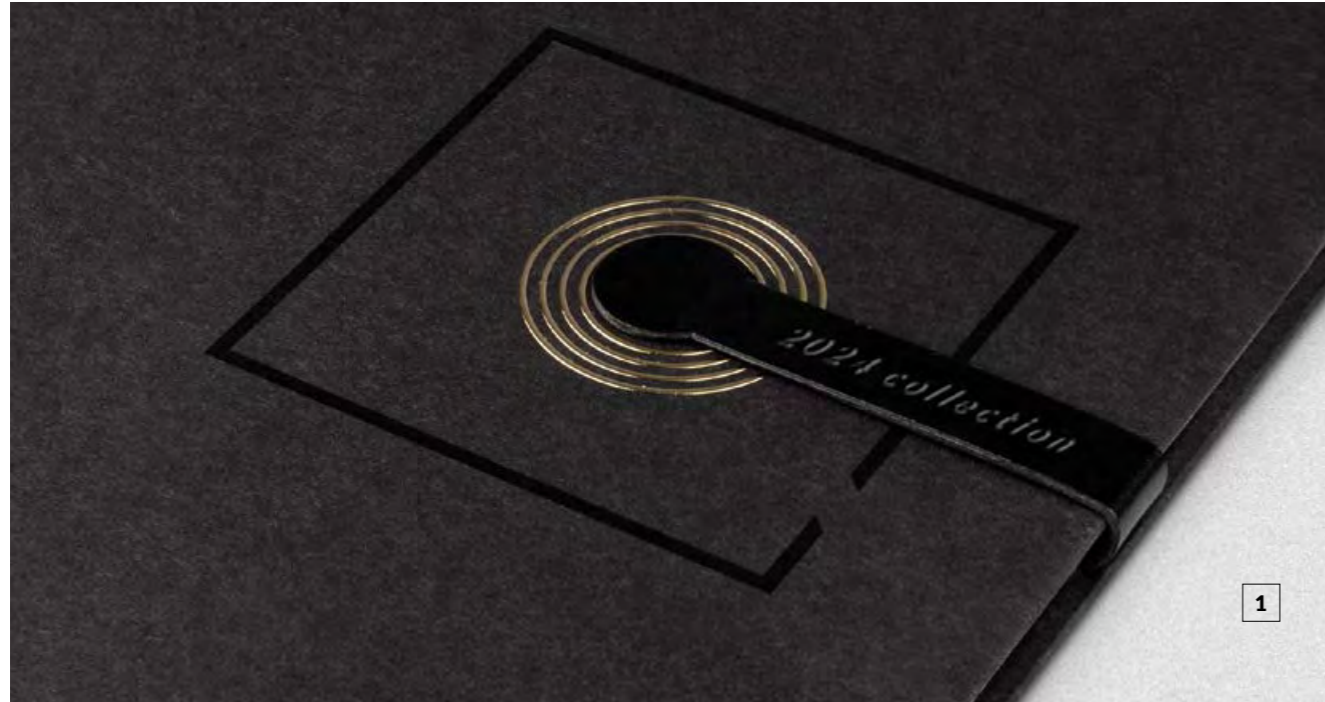

1



2

INSPIRATION / INSPIRATION

couverture / cover*

1 - NATURA, 2 - IDEO

marquage / marking method

1 - impression, embossage par feuille plastique embossage sur patte / print, foil stamping, debossing on the synthetic leather tab

complément / add-on**

1 - patte MINI / MINI synthetic leather tab
2 - patte MAXI / MAXI synthetic leather tab

*TYPE ET COULEUR DE COUVERTURE AU CHOIX. / TYPE AND COLOUR OF THE COVER MATERIAL ACCORDING TO YOUR CHOICE.
** TYPE ET COULEUR DE COUVERTURE AU CHOIX EXCEPTÉ POUR LES COUVERTURES EN PAPIER ET rPET. / TYPE AND COLOUR OF THE COVER MATERIAL ACCORDING TO YOUR CHOICE, EXCLUDING PAPER AND rPET COVERS.

**VOS NOTES
ENFERMÉES EN
TOUTE SÉCURITÉ**

YOUR NOTES
SAFELY LOCKED



3

INSPIRATION / INSPIRATION

couverture / cover*

VIVELA + CROSS

liaison de couverture / cover combinations*** 9

marquage / marking method

embossage grand format, embossage sur patte, couture grand format / large format debossing, debossing on the synthetic leather tab, creative stitching

complément / add-on**

patte personnalisée / customised synthetic leather tab

***SÉLECTION DE LIAISONS DISPONIBLES SUR LA PAGE 83. / SELECTION OF AVAILABLE TEMPLATES CONNECTIONS FOR COVERS ON THE PAGE 83.



1 À POSER / LYING



2 DEBOUT / STANDING

INSPIRATION / INSPIRATION

calendrier / calendar à poser / lying
 année / year design 2B
 couverture / cover* CANVAS
 marquage / marking method embossage / debossing

LES MARQUAGES DE COUVERTURES DÉDIÉES, LES MISES EN PAGE DES CALENDRIERS ET LES CARNETS SE TROUVENT À PARTIR DE LA PAGE 77. / DEDICATED MARKING METHODS OF COVERS, LAYOUTS OF CALENDARS AND NOTEBOOKS ARE AVAILABLE FROM PAGE 77.

INSPIRATION / INSPIRATION

calendrier / calendar debout / standing
 année / year design 2B
 couverture / cover* VIVELA
 marquage / marking method embossage / debossing

*TYPE ET COULEUR DE COUVERTURE AU CHOIX EXCEPTÉ rPET. / TYPE AND COLOUR OF THE COVER MATERIAL ACCORDING TO YOUR CHOICE, EXCLUDING rPET COVERS.



BOITE ENVELOPPE / ENVELOPE BOX

dimension / size

matériau / material

marquage / marking method

BOITE À COUVERCLE / BOX WITH A LID

pour toute dimension hors 504T, carnet A6 /
for any format except 504T, A6 notebook

papier teint dans la masse – noir ou papier kraft /
mass dyed paper – black or kraft paper

embossage de feuille plastique, sérigraphie / foil stamping, silk-screen

**FAITES
UN BONNE
PREMIÈRE
IMPRESSION**

MAKE A FIRST
IMPRESSION



BOITE COULISSANTE / SLIDING BOX

dimension / size

matériau / material*

marquage / marking method

pour toute dimension hors 504T, carnet A6 /
for any format except 504T, A6 notebook

papier teint dans la masse ou papier kraft /
mass dyed paper or kraft paper

embossage de feuille plastique, sérigraphie / foil stamping, silk-screen

*COULEURS DISPONIBLES SUR LA PAGE 75. / AVAILABLE COLORS ON PAGE 75.





GOMME HORIZONTALE RONDE 1,7 mm / 1,7 mm ROUND HORIZONTAL ELASTIC BAND*

*FIXATION D'UNE GOMME UNIQUEMENT EN CAS D'UNE COUVERTURE DURE EN PAPIER, QUERK I FORMAT 504T. / FITTING THE ROUND BAND ONLY ON A HARDCOVER EXCLUDING PAPER COVERS, QUERK AND 504T FORMAT.



GOMME POUR EFFACER AVEC EMPLACEMENT POUR STYLO / SPINE ELASTIC PEN HOLDER

CORDELETTE POUR STYLO / ELASTIC PEN HOLDER



GOMME HORIZONTALE PLATE 10 mm AVEC EMPLACEMENT POUR STYLO / 10 mm FLAT HORIZONTAL ELASTIC BAND WITH A LOOP

MODÈLE UTILE - OFFICE DES BREVETS DE LA RÉPUBLIQUE DE POLOGNE. / UTILITY MODEL PATENT OFFICE OF THE REPUBLIC OF POLAND.





GOMME PLATE 10 mm /
10 mm FLAT VERTICAL
ELASTIC BAND



**MODE DE FIXATION DE LA GOMME
SUR LE DOS DE COUVERTURE /**
WAY OF ASSEMBLING THE ELASTIC
BAND ON THE BACK COVER.



GOMME VERTICALE PLATE
10 mm + M15 /
10 mm FLAT VERTICAL
ELASTIC BAND + M15

GOMME PLATE FLAT ELASTIC BAND 10 mm	GOMME RONDE ROUND ELASTIC BAND 1,7 mm	RUBAN RIBBON 6 mm	COULEUR COLOUR
			noir / black
			gris / grey
			marron / brown
			bleu marine foncé / navy blue
			bleu marine clair / light navy blue
			bleu / blue
			jaune / yellow
			vert / green
			céladon / willow-green
			bordeaux / maroon NEW
			rouge / red
			orange / orange
			magenta / magenta
			beige / beige

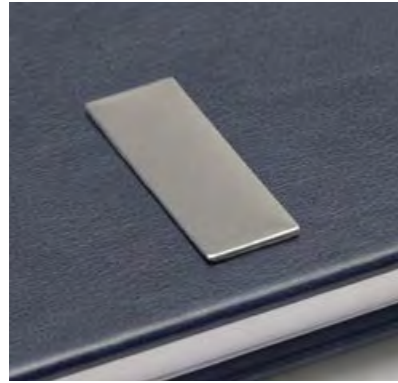

M1*
PLAQUE EN ALUMINIUM /
ALUMINUM PLATE

dimension / size

40 × 14 mm

zone à graver / engraving area

38 × 12 mm



M2*
PLAQUE EN ALUMINIUM
ET ANNÉE EMBOSÉE /
ALUMINUM PLATE WITH
EMBOSSSED YEAR*

dimension / size

40 × 14 mm

zone à graver / engraving area

26 × 12 mm



M3
ANNÉE FINOCHROME
COLLÉE SUR
LA COUVERTURE /
FINOCHROME YEAR
STICKED TO COVER

dimension / size

41 × 8,5 mm

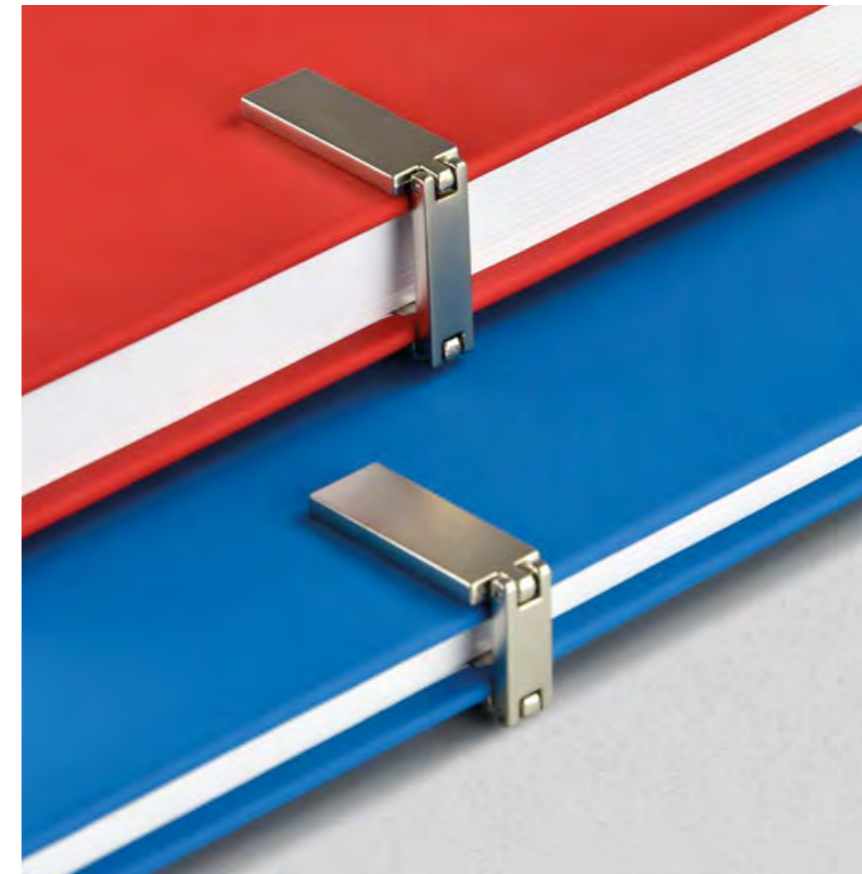

M11**
AGRAFE EN MÉTAL
(ARGENTÉ MAT)
POSÉE AVEC UN RIVET
DOTÉE D'UNE CHARNIÈRE
EN MÉTAL FERMÉE PAR UN
AIMANT /
METAL CLASP
(SILVER MATTE) FIXED
WITH A METAL HINGE,
CLOSING WITH MAGNETS

dimension / size

32 × 12 mm

zone à graver / engraving area

28 × 8 mm



M4
ANNÉE FINOCHROME
COLLÉE SUR
LA COUVERTURE /
FINOCHROME YEAR
STICKED TO COVER

dimension / size

10 × 10 mm



M8
PENDRIVE 32 GB FIXÉ
DANS LA COUVERTURE /
32 GB FLESH DRIVE
HOLDER IN THE COVER

dimension / size

34 × 11 mm

zone à graver / engraving area

28 × 8 mm



M15
PLAQUE EN MÉTAL
(ARGENTÉ MAT)
SUR UNE GOMME 10 mm /
RECTANGULAR (SILVER
MATTE) METAL PLATE
ON 10 mm ELASTIC BAND

dimension / size

45 × 14 mm

zone à graver / engraving area

34 × 12 mm



M17C
POINTE FINOCHROME
CUIVRÉE, COLLÉE SUR
LA COUVERTURE /
COPPER FINOCHROME DOT
STICKED TO COVER

dimension / size

5 × 5 mm



M17B
POINTE FINOCHROME
ARGENTÉE, COLLÉE SUR
LA COUVERTURE /
SILVER FINOCHROME DOT
STICKED TO COVER

dimension / size

5 × 5 mm

*FIXATION 10 mm DU BORD DE LA COUVERTURE. / MOUNTING 10 mm FROM THE EDGE OF COVER .

**DISPONIBLE EN FORMAT JOURNALIER ET HEBDOMADAIRE DANS LES CALENDRIERS ET LES CARNETS. / AVAILABLE FOR DAILY CALENDARS, WEEKLY CALENDARS AND NOTEBOOKS.



M18A
 POINTE FINOCHROME
 DORÉE, COLLÉE SUR
 LA COUVERTURE /
 GOLDEN FINOCHROME
 CIRCLE STICKED TO COVER

dimension / size

23 × 23 mm



M18B
 POINTE FINOCHROME
 ARGENTÉE, COLLÉE SUR
 LA COUVERTURE /
 SILVER FINOCHROME
 CIRCLE STICKED TO COVER

dimension / size

23 × 23 mm



M19
 POINTE FINOCHROME
 DORÉE, COLLÉE SUR
 LA COUVERTURE /
 GOLDEN FINOCHROME
 CIRCLE STICKED TO COVER

dimension / size

16 × 16 mm



PATTE MINI**
 MINI SYNTHETIC LEATHER TAB
 FERMÉE PAR AIMANT, AIMANT
 DISSIMULÉ DANS LA COUVERTURE /
 WITH MAGNETIC CLOSURE, MAGNET
 HIDDEN IN THE FRAME



PATTE MAXI**
 MAXI SYNTHETIC LEATHER TAB
 FERMÉE PAR AIMANT
 AVEC EMPLACEMENT POUR
 STYLO, AIMANT DISSIMULÉ
 DANS LA COUVERTURE /
 WITH MAGNETIC CLOSURE
 AND PEN HOLDER, MAGNET
 HIDDEN IN THE FRAME



M20A
 LIGNE FINOCHROME
 DORÉE COLLÉE SUR
 LA COUVERTURE /
 GOLDEN FINOCHROME
 LINE DOT STICKED TO
 COVER

dimension / size

0,9 × 45 mm



M20B
 LIGNE FINOCHROME
 ARGENTÉE COLLÉE SUR
 LA COUVERTURE /
 SILVER FINOCHROME LINE
 DOT STICKED TO COVER

dimension / size

0,9 × 45 mm



M16*
 MORAILLON EN MÉTAL
 (NOIR MAT.) FIXÉE SUR
 LA COUVERTURE ARRIÈRE
 AVEC UNE ENVELOPPE /
 METAL HASP (BLACK MAT)
 MOUNTED ON THE BACK
 COVER WITH ENVELOPE

dimension / size

30 × 15 mm

zone à graver / engraving area

27 × 12 mm

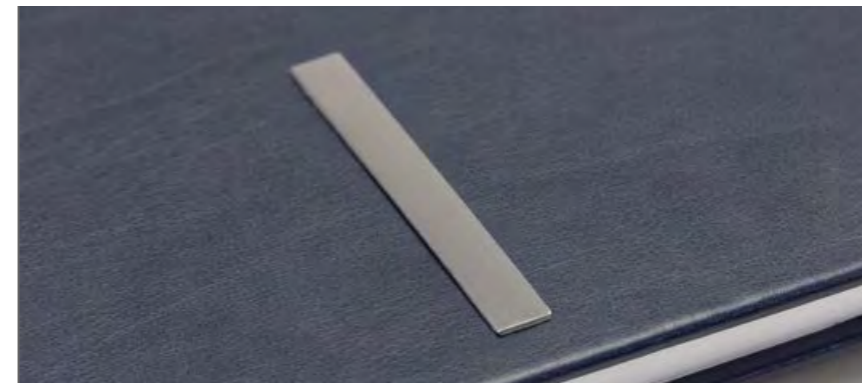

M21
 PLAQUE ALUMINIUM
 POUR PERSONNALISATION /
 ALUMINIUM PLATE
 FOR PERSONALISATION

dimension / size

70 × 8 mm



PERSONNALISATION GRAVURE
 (selon un projet)
 ENGRAVED PERSONALISATION
 (according to design)

police recommandée /
 recommended font

VERDANA Regular min. 14 points /
 min 14 pkt. VERDANA REGULAR

*DISPONIBLE EN FORMAT JOURNALIER ET HEBDOMADAIRE DANS LES CALENDRIERS ET LES CARNETS. / AVAILABLE FOR DAILY CALENDARS, WEEKLY CALENDARS AND NOTEBOOKS.

**EXCEPTÉ COUVERTURES EN PAPIER ET rPET. / EXCLUDING PAPER AND rPET COVERS.



B1 NEW
 POINTE DE BAMBOU
 AVEC UNE ANNÉE 3D /
 BAMBOO CIRCLE WITH
 3D YEAR

dimension / size

30 × 30 mm



N1 NEW
 GRAINES DE PIN /
 PINE SEEDS

dimension / size

12 × 12 mm



autres / other

revêtement soft, pointe de
 contact, recharge x-20 - 1 mm,
 encre bleu, longueur d'écriture
 environ 1000 m / barrel soft
 finished, touch tip, x-20 - 1 mm
 refill, blue ink color, writing length
 approximately 1000 m



**POCHETTE TRIANGULAIRE
 EN FILM PLASTIQUE**
 TRIANGULAR FOIL POUCH

dimension / size

80 × 80 mm
 100 × 100 mm
 120 × 120 mm



**POCHETTE RECTANGULAIRE
 EN FILM PLASTIQUE**
 FOIL BUSINESS CARD POCKET

dimension / size

90 × 60 mm

dimensions de carte de visite /
 business card size

≤ 85 × 55 mm



RUBAN DE SUBLIMATION
 (selon le projet)
 SUBLIMATION RIBBON
 (according to design)

dimension / size

8 mm
 10mm



G0072 NEW
 STYLO MÉTALLIQUE
 AUTOMAT. AVEC UN
 ÉLÉMENT EN LIÈGE /
 AUTOMATIC METAL PEN
 WITH KORK ELEMENT

dimension / size

144 × 10 mm

zone à graver / engraving area

50 × 5 mm



G0073 NEW
 STYLO MÉTALLIQUE
 AUTOMAT. AVEC UN
 ÉLÉMENT EN BAMBOU /
 AUTOMATIC METAL PEN
 WITH BAMBOO ELEMENT

dimension / size

144 × 10 mm

zone à graver / engraving area

50 × 5 mm



impression / print

BORDS TEINTÉS*
 COLOURED EDGES

dimension / size

pour tout format / for any format

projet de teinture des bords /
 coloured edges design

personnalisé / customised

commande / order

min. 100 pcs. / MOQ pcs.

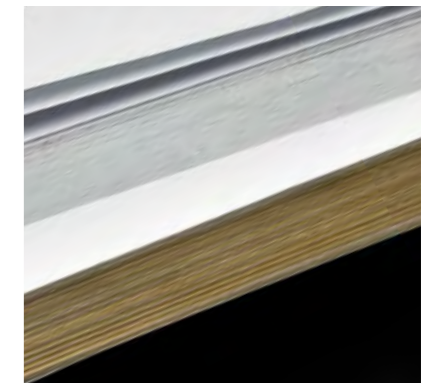

film vidéo / foil

*NE CONCERNE PAS LES BLOCS EN PAPIER DE PIERRE. POSSIBILITÉ DE TEINTURE DES BORDS PAR IMPRESSION CMJN OU REVÊTEMENT PAR FILM EN PLASTIQUE DORÉ OU ARGENTÉ. / DOES NOT APPLY TO STONE PAPER BLOCKS. POSSIBLE COLOURING OF THE EDGES BY PRINTING IN CMYK OR FINISHING WITH GOLD OR SILVER FOIL.



PAGE DE GARDE ET ENVELOPPE PERSONNALISÉE
CUSTOMISED
ENDPAPERS & ENVELOPE

dimension / size

pour tout format / for any format

matériau / material

papier doré / decorative paper
papier teinté dans la masse /
mass dyed paper
papier kraft / kraft paper
papier blanc ou chamois /
white or ivory paper

marquage / marking method

impression / print

projet / design

personnalisé / customised



CALQUE
TRACING PAPER

dimension / size

pour tout format / for any format

marquage / marking method

impression une face (selon projet) /
one-sided printing (according to
design)

application / application

jaquette, insert / wrapper,
insert page



INSERT DÉCOUPÉ PERSONNALISÉ
CUSTOMISED INSERT PAGE

dimension / size

pour tout format / for any format

matériau / material

papier teint dans la masse /
mass dyed paper
papier kraft / kraft paper

marquage / marking method

impression / print

projet / design

personnalisé / customised

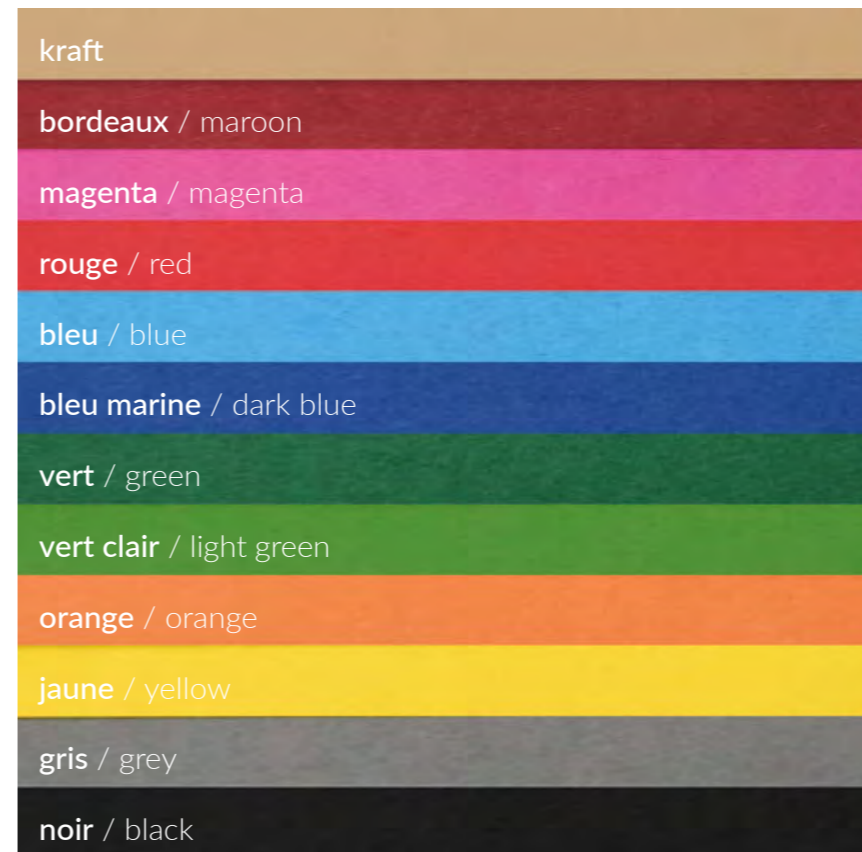

PAPIER KRAFT ET TEINT DANS LA MASSE POUR ENVELOPPES, INSERTS, PAGE DE GARDES ET EMBALLAGES

KRAFT AND MASS DYED PAPER FOR ENVELOPPES, INSERTS, INSERT PAGES AND PACKAGINGS



PAGE DE GARDE / ENDPAPER



ENVELOPPE / ENVELOPE



INSERT / INSERT PAGE



BLOC PERSONNALISÉ / CUSTOMISED BLOCK

FORMATAGE COVER	EMBOSSAGE DEBOSSING	EMBOSSAGE AVEC UN FILM PLASTIQUE FOIL DEBOSSING	GRAVURE ENGRAVING	COUTURE SEWING	IMPRESSION PRINT
rPET					✓
QUERK					✓
RE-COVER				✓	✓
SAVANA	✓		✓	✓	✓
NATURA	✓	✓	✓	✓	✓
GAMBO	✓			✓	✓
CROSS	✓		✓	✓	✓
CANVAS	✓		✓	✓	✓
IDEO	✓	✓	✓	✓	✓
PIKO	✓		✓	✓	✓
GUMA	✓	✓	✓	✓	✓
IMAGE	✓	✓	✓	✓	✓
CARBON	✓		✓	✓	✓
COLORADO	✓	✓	✓	✓	✓
DURO	✓			✓	✓
KRAFT	✓	✓	✓	✓	✓
FLESZ	✓	✓	✓	✓	✓
VIVELA	✓	✓	✓	✓	✓
ITALIANO	✓	✓	✓		

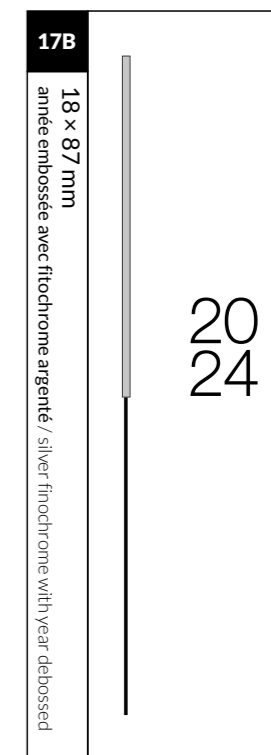
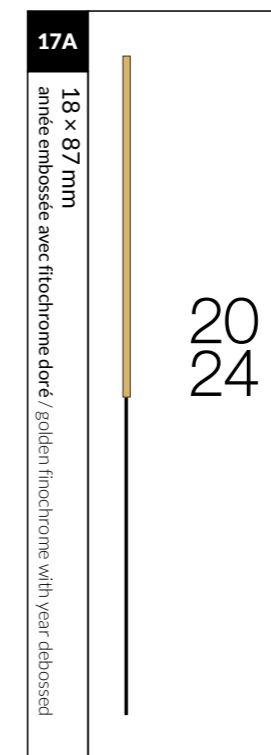
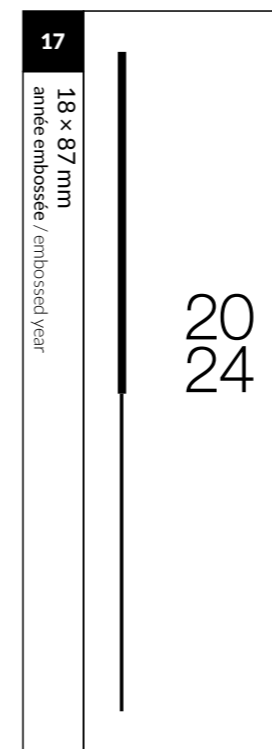
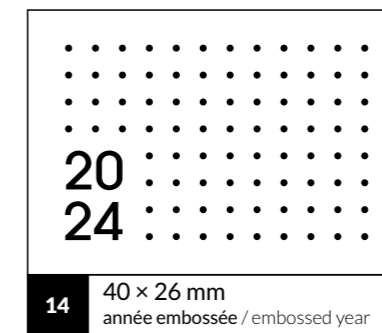
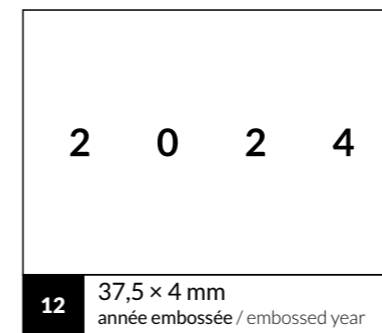
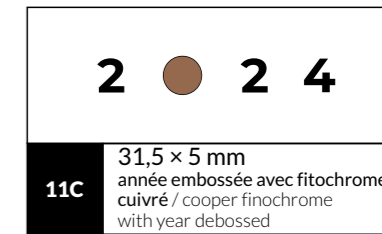
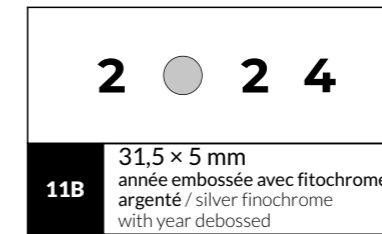
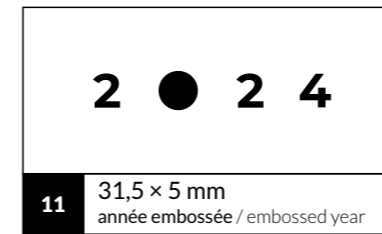
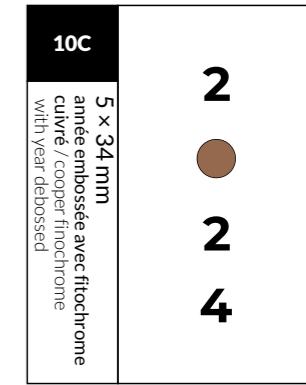
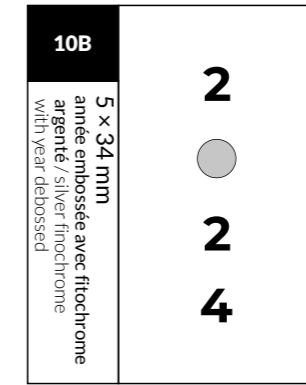
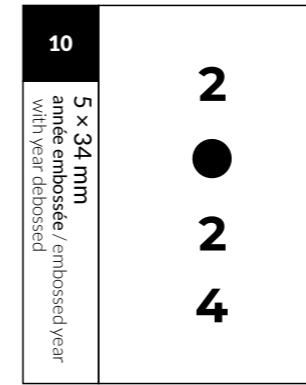
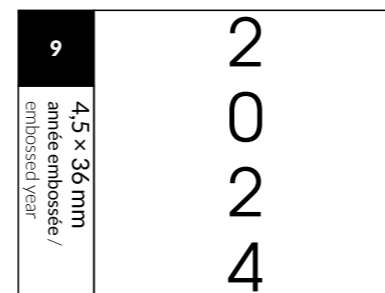
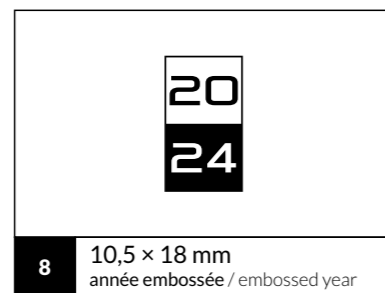
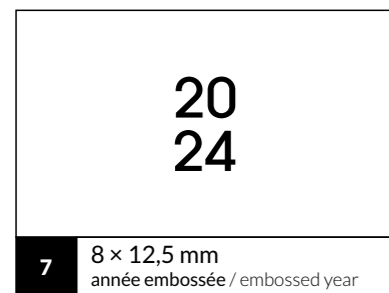
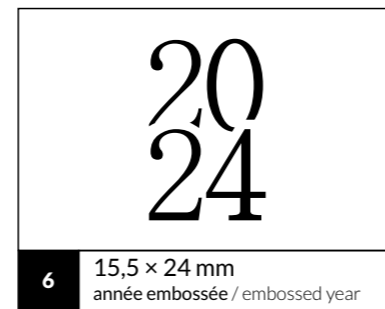
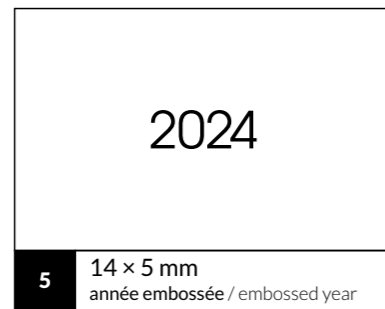
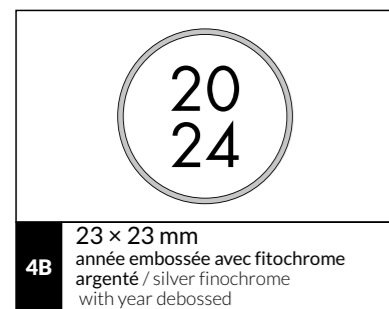
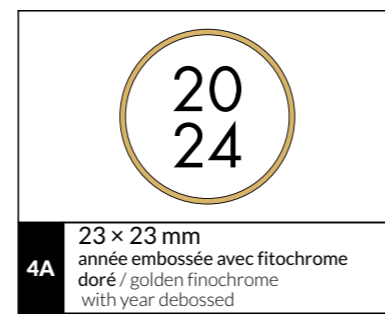
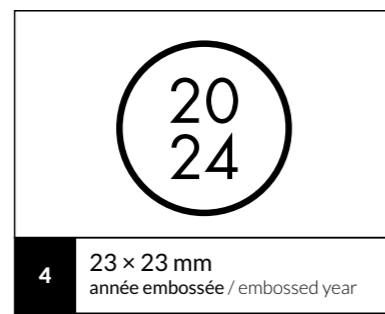
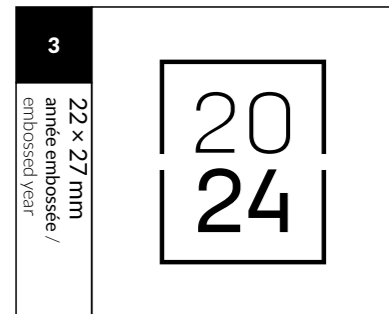
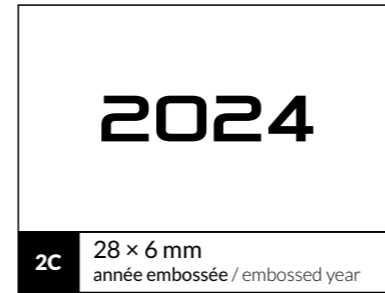
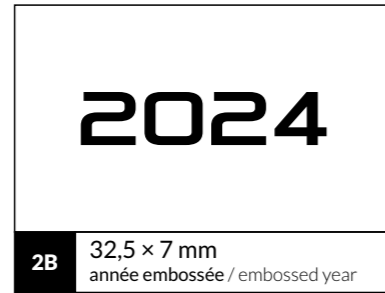
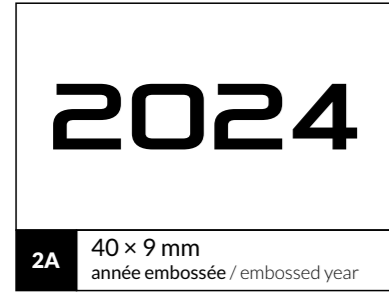
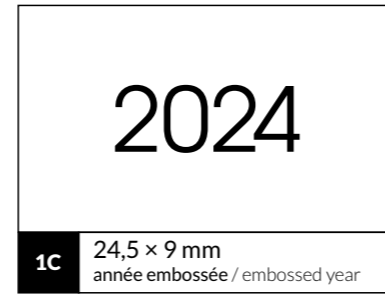
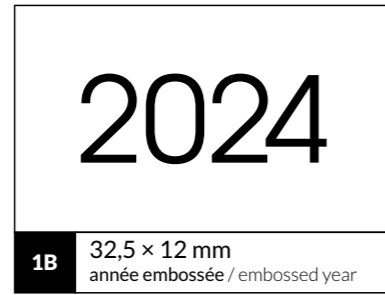
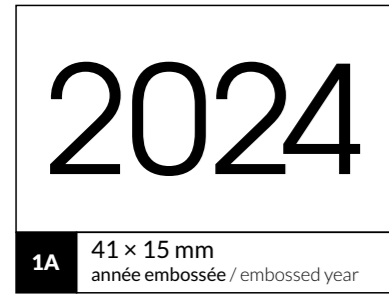

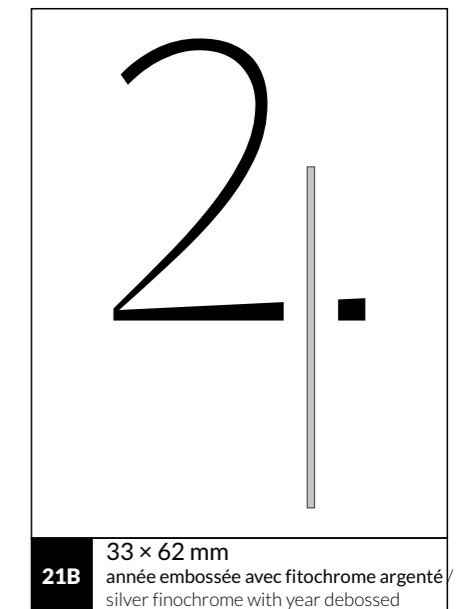
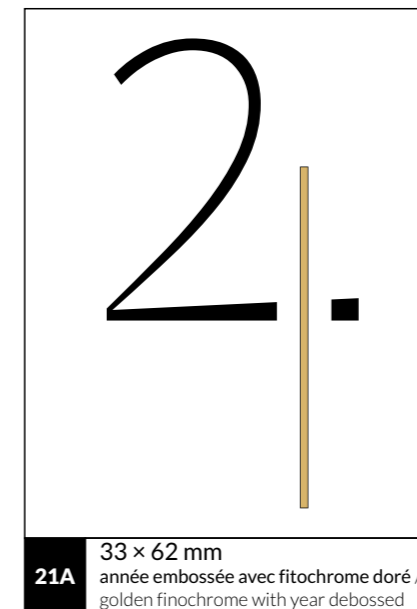
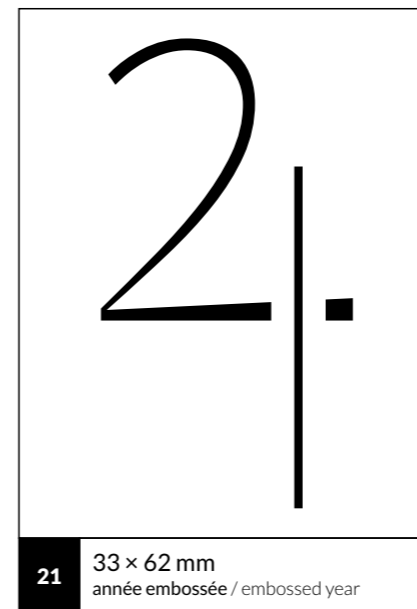
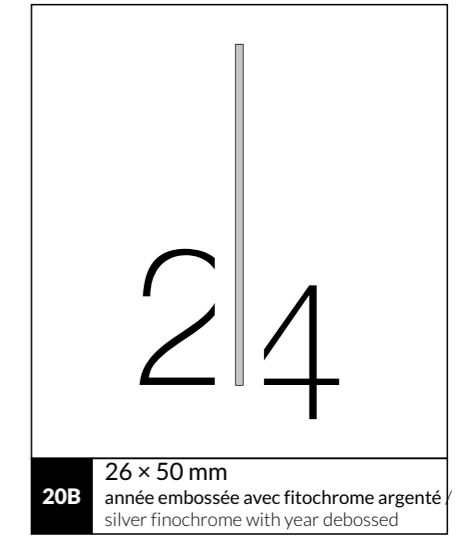
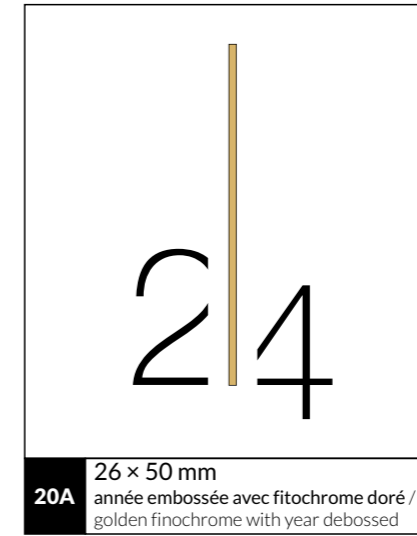
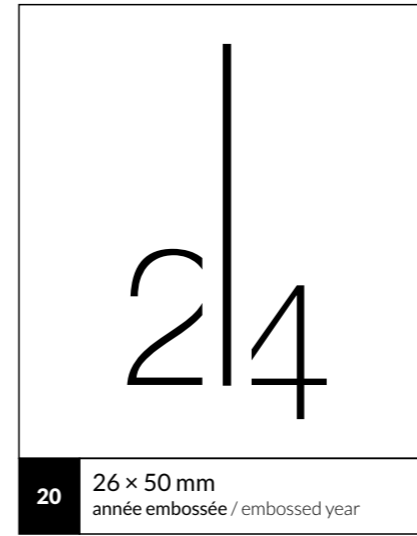
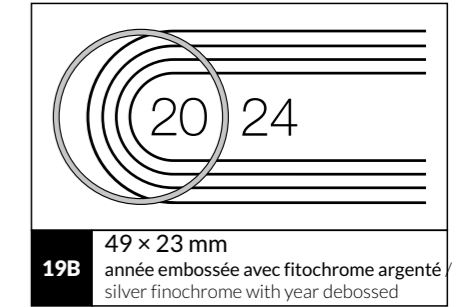
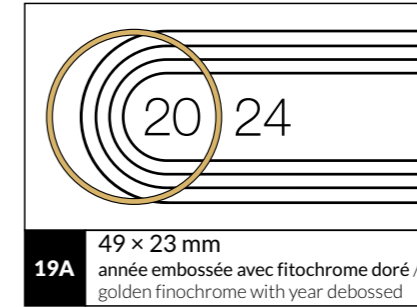
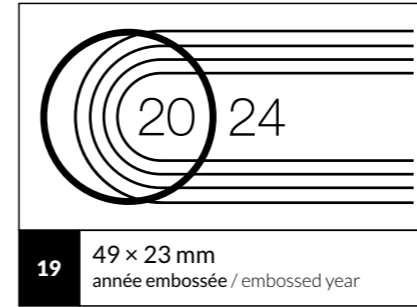
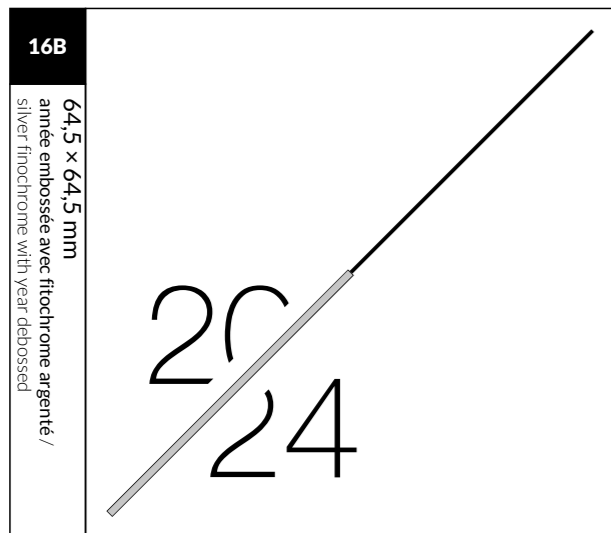
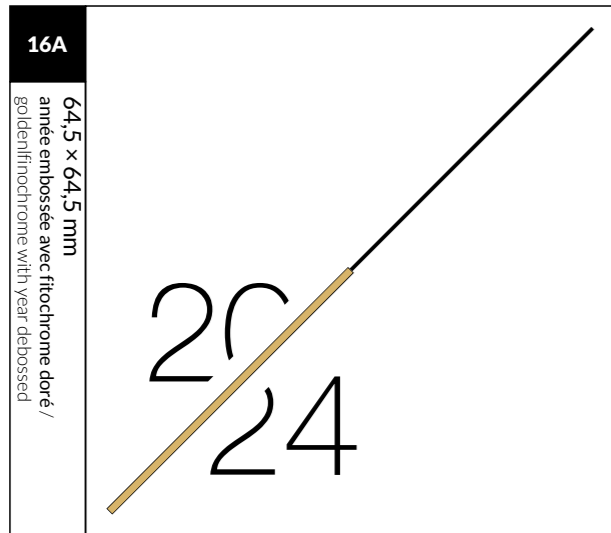
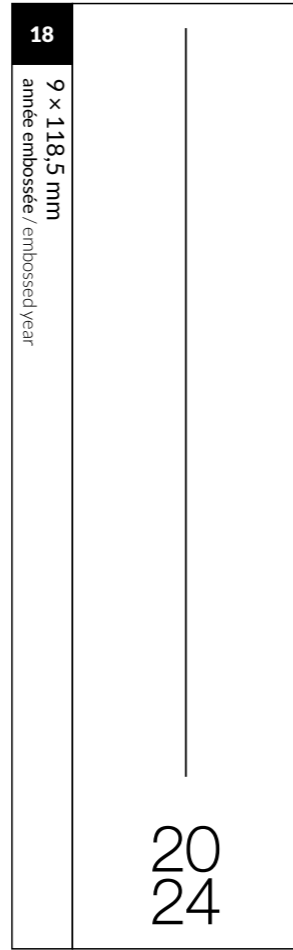
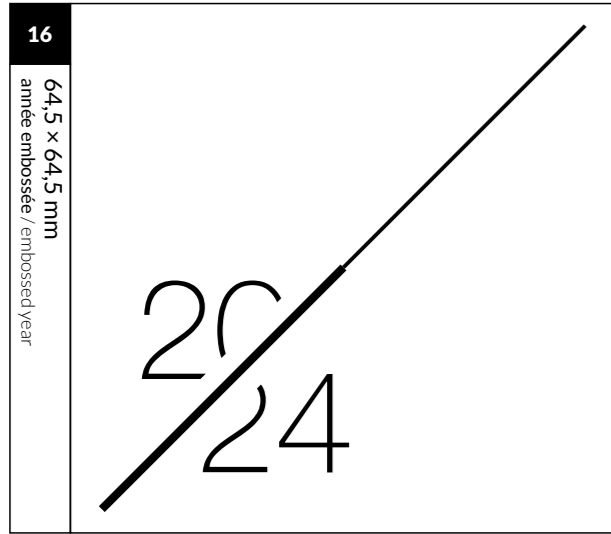

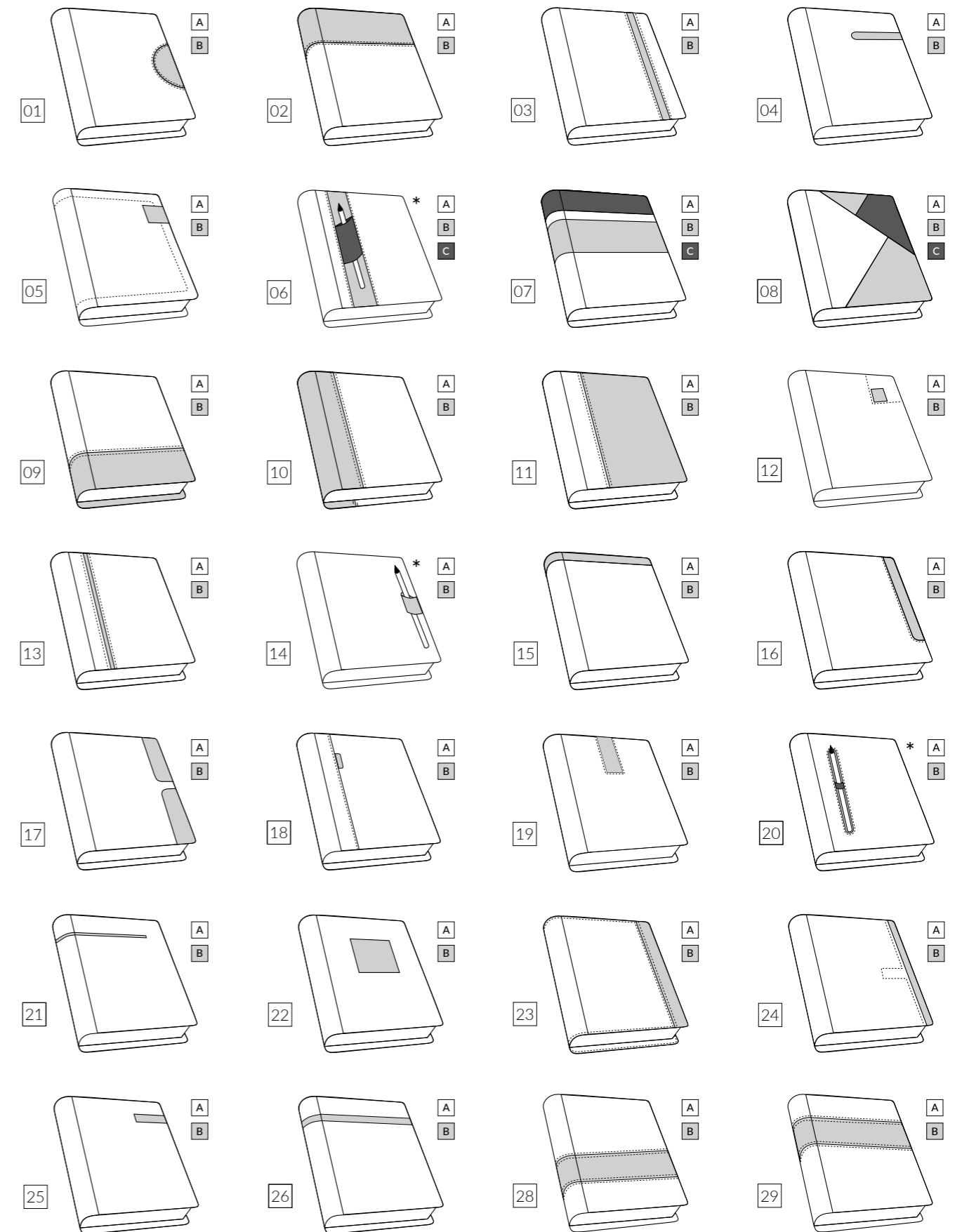
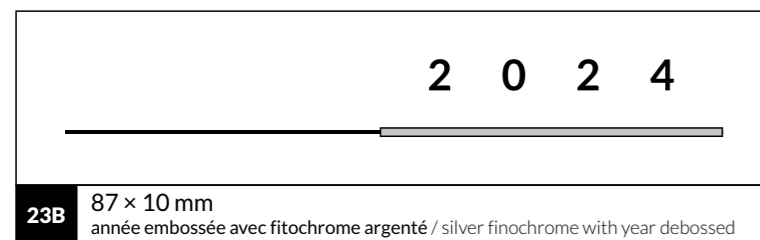
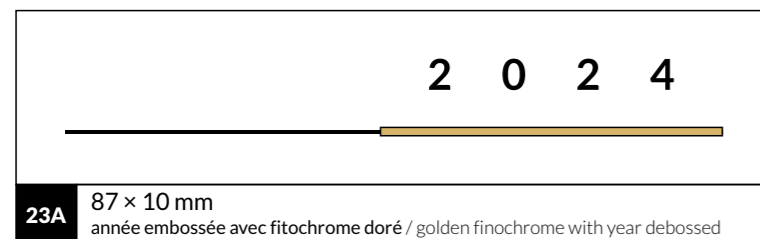
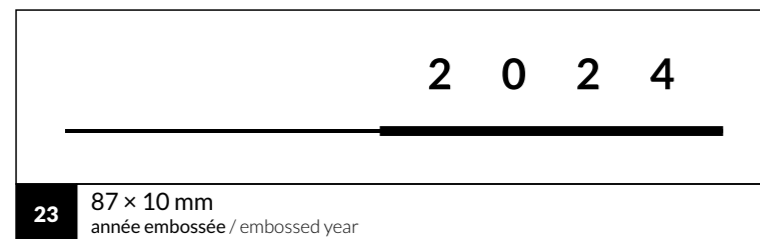
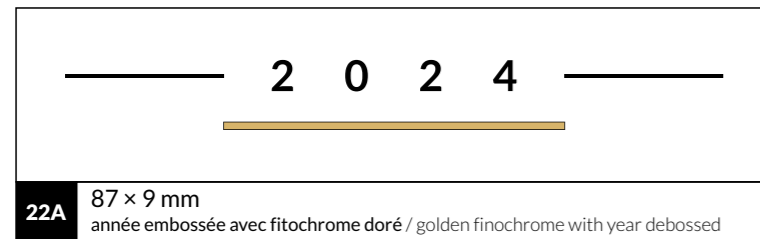
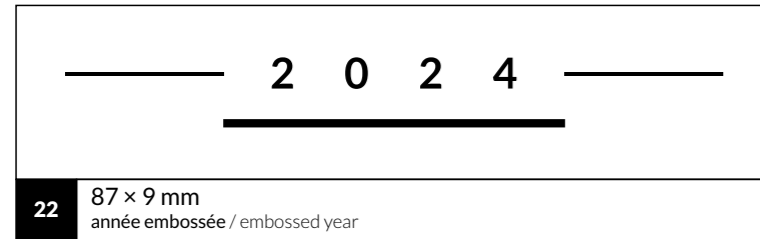

* CORDELETTE POUR STYLO. / ELASTIC PEN HOLDER.

LA NUMÉROTATION INDICUÉE EST UNE LISTE DE COMBINAISSONS DE COUVERTURES DISPONIBLES, À L'EXCLUSION DES COUVERTURES EN PAPIER ET rPET. / THE NUMBERING SHOWN IS THE LIST OF THE COVER COMBINATIONS AVAILABLE, EXCLUDING PAPER AND rPET COVERS.

MATRICES GRAND FORMAT / LARGE FORMAT STAMPS

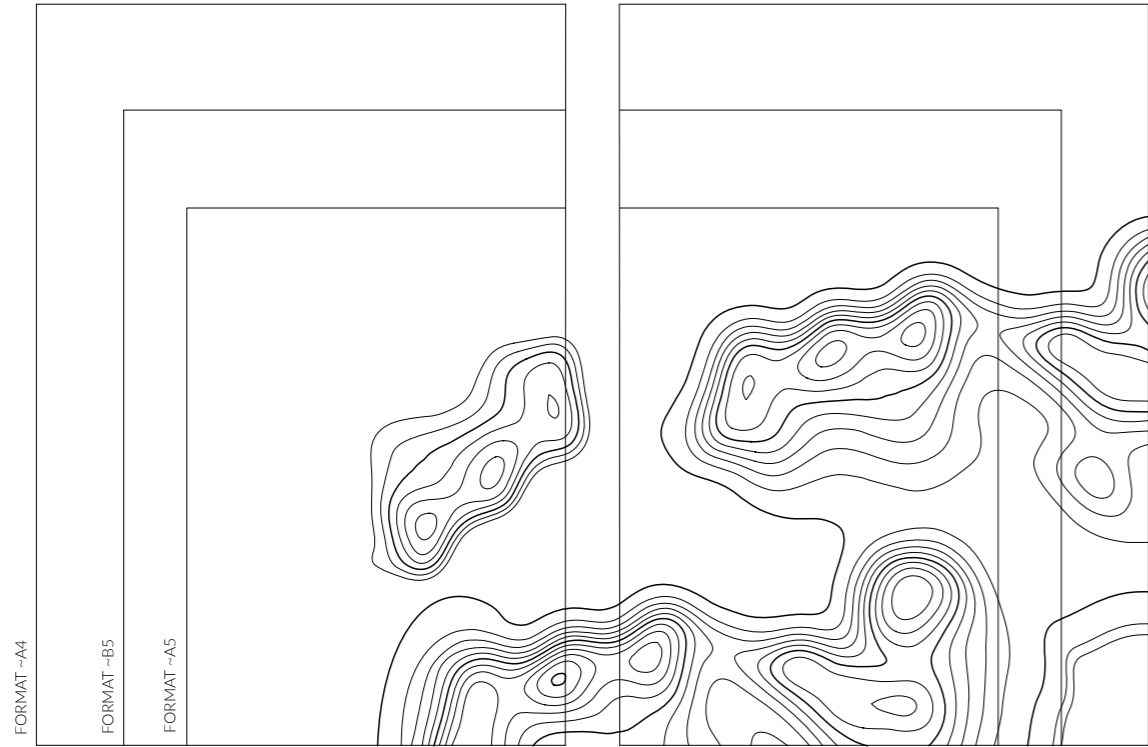

1 294 × 200 mm
modèle embossé / debossed pattern

LA LARGEUR DU BOUT DÉPEND DU BLOC COMMANDÉ. /
WIDTH OF THE SPINE DEPENDING ON THE ORDERED INNER BLOCK.



4 140 × 69 mm
modèle embossé / debossed pattern

MATRICE AJUSTÉE AUX FORMATS -A5 ET -A4 /
STAMPING ADAPTED TO -A5 AND -A4 FORMATS

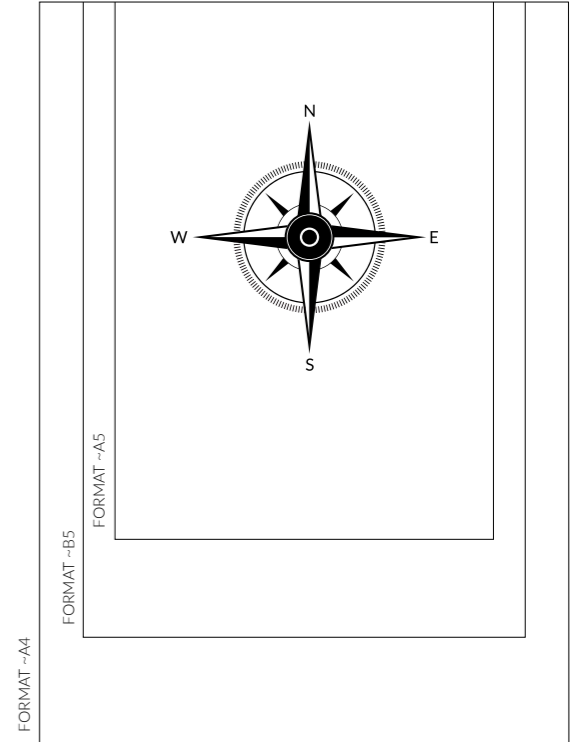

5 101 × 101 mm
modèle embossé / debossed pattern

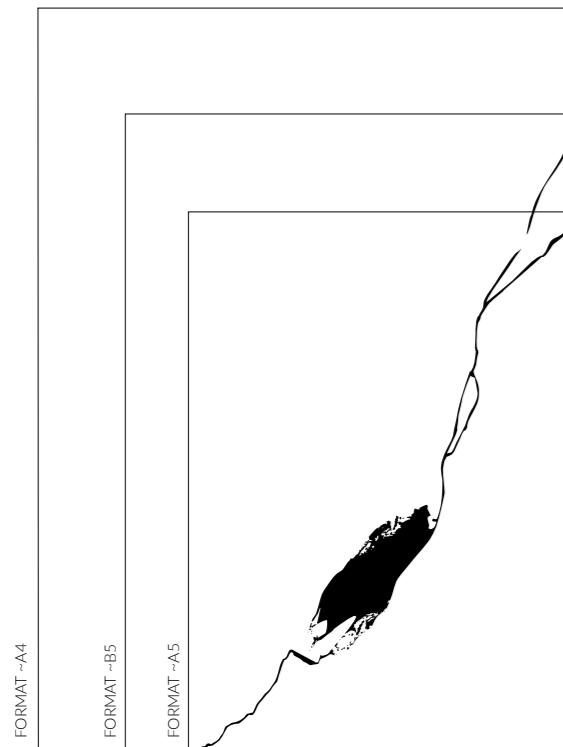

2 167 × 240 mm
motif embossé / debossed pattern

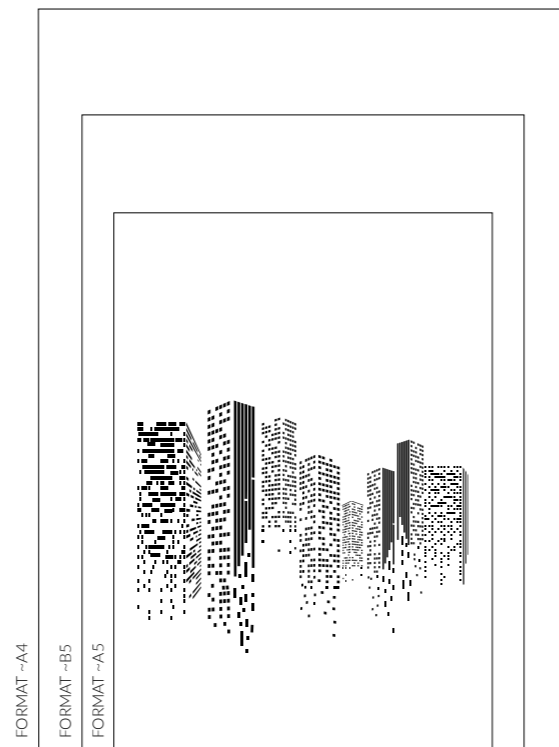

3 125 × 96 mm
modèle embossé / debossed pattern

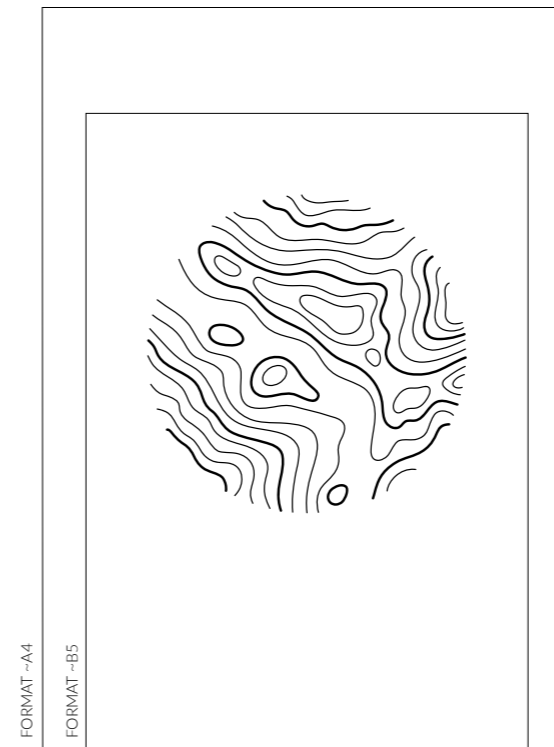

6 121 × 120 mm
modèle embossé / debossed pattern

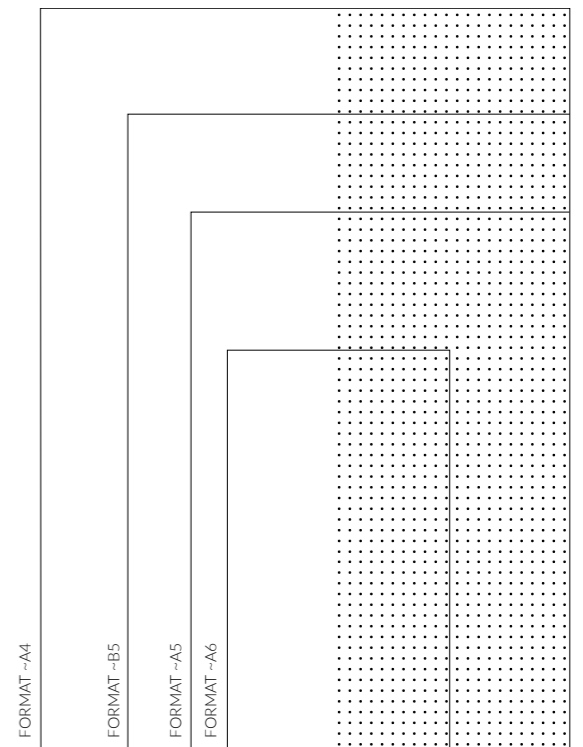

7 86 × 284 mm
modèle embossé / debossed pattern

LES MATRICES PRÉSENTÉES POUR EMBOSSAGE GRAND FORMAT PEUVENT ÊTRE UTILISÉES GRATUITEMENT POUR TOUTE COMMANDE. DANS CE CAS, LE CLIENT NE SUPPORTE QUE LE COÛT DU SERVICE D'EMBOSSAGE LUI-MÊME SELON LA LISTE DE PRIX EN VIGUEUR (SANS LE COÛT DE LA MATRICE). / PRESENTED STAMPING USED FOR THE LARGE FORMAT DEBOSSINGS CAN BE USED FREE OF CHARGE FOR ANY ORDER. IN THIS CASE, THE CUSTOMER PAYS ONLY THE COST OF THE STAMPING SERVICE IN ACCORDANCE WITH THE APPLICABLE PRICE LIST (WITHOUT THE COSTS OF THE STAMP).

501D 503D 508D

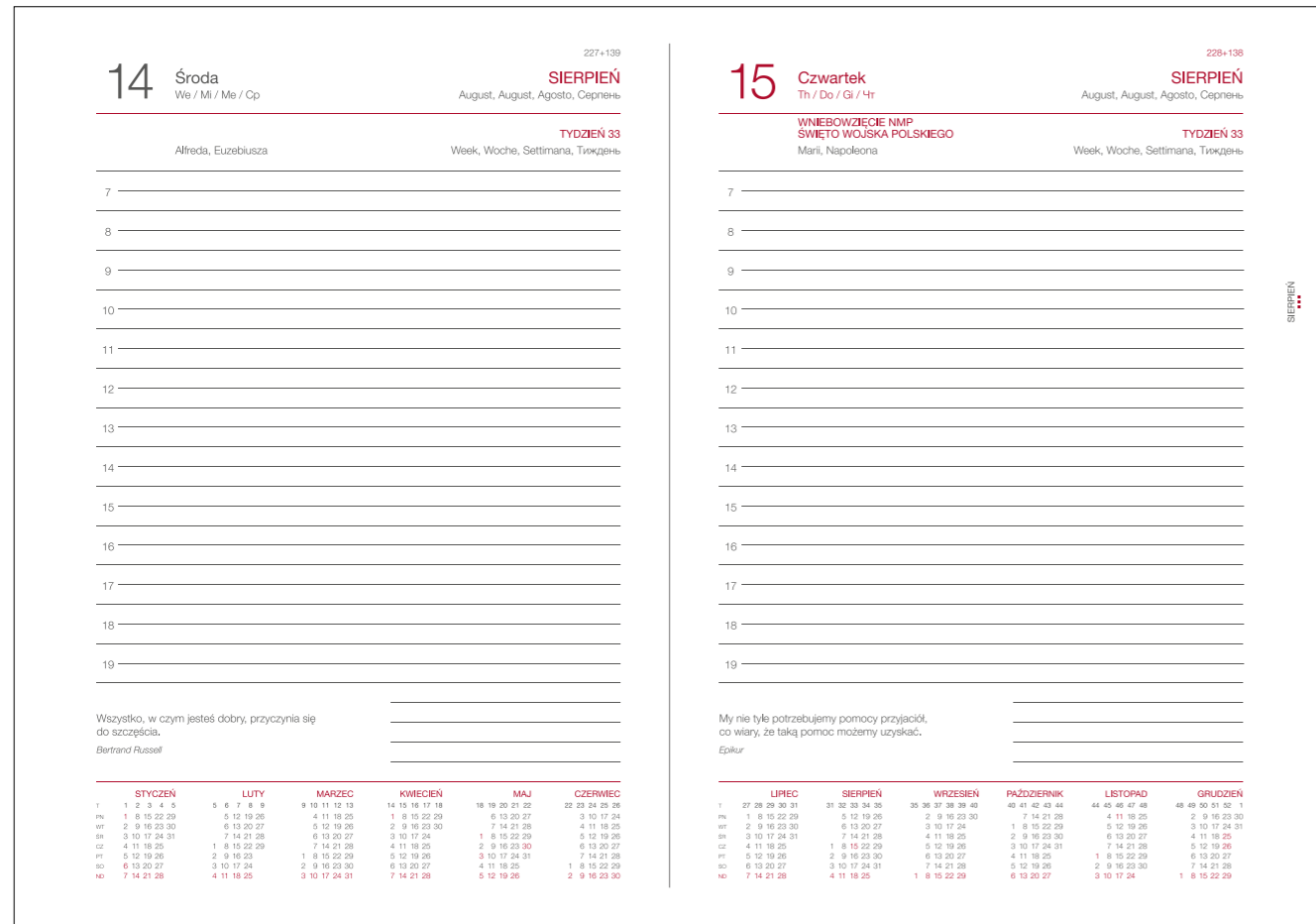

CALENDRIER / CALENDAR	501D	503D	508D	INDEX / INDEX		perforation de cornières corner perforation
format / format	200 x 280 mm ~A4	143 x 203 mm ~A5	162 x 240 mm ~B5	impression printed	découpe tabbed	
nombre de pages / pages	368	368	368			
papier blanc / white paper impression / print	gris et bordeaux grey-maroon	✓	✓	✓	✓	✓
	gris et bleu marine grey-dark blue	✓	✓	✓	✓	✓
	gris et graphite grey-graphite					
papier chamois / ivory paper impression / print	gris et bordeaux grey-maroon	✓	✓	✓	✓	✓
	gris et bleu marine grey-dark blue	✓	✓	✓	✓	✓
	gris et graphite grey-graphite					
papier recyclé / recycled paper impression / print		✓		✓		
papier d'herbes / grass paper impression / print						
papier de pierre / stone paper impression / print						
langue / language	GB DE IT UA					
données personnelles / personal data	✓	✓	✓			
compteur de jours / day counter	✓	✓	✓			
numérotation des semaines / week numbering	✓	✓	✓			
fiche de planification des objectifs / goal planning sheet	✓	✓	✓			
fêtes internationales / international holidays	✓	✓	✓			
calendrier succinct / shortened calendar 2023-2025	✓	✓	✓			
agenda annuel / annual planner	✓	✓	✓			
agenda mensuel / monthly planner	✓	✓	✓			
calendrier annuel / annual calendar 2024	✓	✓	✓			
jour du prénom / name day	✓	✓	✓			
aphorismes / aphorisms	✓	✓	✓			
relevé de route / accident statement	✓	✓	✓			
carnet / notebook	✓	✓	✓			
cartes / maps						

506D

10 **Poniedziałek**
Mo / Mo / Lu / Di

160-204
CZERWIEC
June, Juni, Giugno, Ҷуниёни

TYDZIEŃ 24
Week, Woche, Settimana, Тиждень

Bogumiła, Malgorzata

7
8
9
10
11
12
13
14
15
16
17
18
19

Wygrzyj bez zychy, przegrzyj bez urazy.
Bruce Lee

11 **Wtorek**
Tu / Di / Mi / Br

161-203
CZERWIEC
June, Juni, Giugno, Ҷуниёни

TYDZIEŃ 24
Week, Woche, Settimana, Тиждень

Barnaby, Felksa

7
8
9
10
11
12
13
14
15
16
17
18
19

Krytyka jest czymś, czego możemy łatwo uniknąć
nie mówiąc nic, nie robiąc nic i będąc nikim.
Ayn Rand

STYCZEŃ	LUTY	MARZEC	KWIECIEŃ	MAJ	CZERWIEC
1 2 3 4 5	6 7 8 9	10 11 12 13	14 15 16 17 18	19 20 21 22	23 24 25 26 27
28 29 30 31	1 2 3 4 5 6	7 8 9 10 11 12	13 14 15 16 17 18	19 20 21 22 23	24 25 26 27 28 29 30

STYCZEŃ	LUTY	MARZEC	KWIECIEŃ	MAJ	CZERWIEC	LIPIEC	SIERPIEŃ	WRZEŚNIEN	PAŹDZIERNIK	LISTOPAD	GRUDZIEŃ
1 2 3 4 5	6 7 8 9	10 11 12 13	14 15 16 17 18	19 20 21 22	23 24 25 26 27	28 29 30 31	1 2 3 4 5 6	7 8 9 10 11 12	13 14 15 16 17 18	19 20 21 22 23	24 25 26 27 28 29 30

510D

5 **Friday**

5+361
JANUARY

1
7
8
9
10
11
12
13
14
15
16
17
18
19
20

6 **Saturday**

6+360
JANUARY

1

I	II	III	IV	V	VI
1 2 3 4 5	6 7 8 9	10 11 12 13	14 15 16 17 18	19 20 21 22	23 24 25 26 27
28 29 30 31	1 2 3 4 5 6	7 8 9 10 11 12	13 14 15 16 17 18	19 20 21 22 23	24 25 26 27 28 29 30

VII	VIII	IX	X	XI	XII
27 28 29 30 31	1 2 3 4 5 6	7 8 9 10 11 12	13 14 15 16 17 18	19 20 21 22 23	24 25 26 27 28 29 30

CALENDRIER / CALENDAR		506D	510D	INDEX / INDEX		perforation de cornières corner perforation
format / format		110 x 160 mm -A6	143 x 203 mm -A5	impression printed	découpe tabbed	
nombre de pages / pages		368	368			
papier blanc / white paper impression / print	gris et bordeaux grey-maroon					
	gris et bleu marine grey-dark blue					
	gris et graphite grey-graphite	✓	✓	✓		
papier chamois / ivory paper impression / print	gris et bordeaux grey-maroon					
	gris et bleu marine grey-dark blue					
	gris et graphite grey-graphite					
papier recyclé / recycled paper impression / print	gris et graphite grey-graphite					
papier d'herbes / grass paper impression / print	gris et graphite grey-graphite					
papier de pierre / stone paper impression / print	gris et graphite grey-graphite					
langue / language		GB DE IT UA	GB			
données personnelles / personal data		✓	✓			
compteur de jours / day counter		✓	✓			
numérotation des semaines / week numbering		✓	✓			
fiche de planification des objectifs / goal planning sheet		✓	✓			
fêtes internationales / international holidays		✓	✓			
calendrier succinct / shortened calendar 2023-2025		✓	✓			
agenda annuel / annual planner		✓	✓			
agenda mensuel / monthly planner		✓	✓			
calendrier annuel / annual calendar 2024		✓	✓			
jour du prénom / name day		✓				
aphorismes / aphorisms		✓				
déclaration routière / accident statement						
carnet / notebook		✓	✓			
cartes / maps						

502T 507T

GRUDZIEŃ December, Dezember, Dicembre, Грудень			TYDZIEŃ 52 Tydzień, Woche, Settimana, Тиждень		
23 Poniedziałek Mo / Mi / Tu / Th	24 Wtorek Tu / Di / We / Th	25 Środa We / Mi / Tu / Th	26 Czwartek Th / Do / Fr / Sa	27 Piątek Fr / Pi / Sa / Su	28 Sobota Sa / Su / Mo / Tu
Wiktoria, Sławomir	WIGILIA BOŻEGO NARODZENIA Adama, Ewy	BOŻE NARODZENIE Eugenii, Anastazj	BOŻE NARODZENIE Dionizego, Szczepana	NARODOWY DZIEŃ ZWYCIĘSKIEGO POWSTANIA WIELKOPOLSKIEGO Kosmy, Damiana	Cezarago, Teofila
7					
8					
9					
10					
11					
12					29 Niedziela Su / So / Do / Pt
13					
14					Dawida, Jonatana
15					
16					
17					
18					Nie możesz kontrolować zachowania Innych, ale zawsze możesz wybrać sposób, w jaki na nie reagujesz. Roy T. Bennett
1 1 2 3 4 5 1 8 15 22 29 2 9 16 23 30 3 10 17 24 31 4 11 18 25 5 12 19 26 6 13 20 27 7 14 21 28	LUTY 1 8 15 22 29 2 9 16 23 30 3 10 17 24 31 4 11 18 25 5 12 19 26 6 13 20 27 7 14 21 28	MARZEC 9 16 13 20 4 11 18 25 5 12 19 26 6 13 20 27 7 14 21 28 8 15 22 29 9 16 23 30 10 17 24 31	KWIECIEŃ 14 15 16 17 18 1 8 15 22 29 2 9 16 23 30 3 10 17 24 31 4 11 18 25 5 12 19 26 6 13 20 27 7 14 21 28	MAJ 18 19 20 21 22 6 13 20 27 7 14 21 28 8 15 22 29 9 16 23 30 10 17 24 31 11 18 25 12 19 26	CZERWIEC 22 23 24 25 26 3 10 17 24 4 11 18 25 5 12 19 26 6 13 20 27 7 14 21 28 8 15 22 29 9 16 23 30
1 27 28 29 30 31 1 8 15 22 29 2 9 16 23 30 3 10 17 24 31 4 11 18 25 5 12 19 26 6 13 20 27 7 14 21 28	LIPEC 27 28 29 30 31 1 8 15 22 29 2 9 16 23 30 3 10 17 24 31 4 11 18 25 5 12 19 26 6 13 20 27 7 14 21 28	SIERPIEŃ 31 30 31 34 35 5 12 19 26 6 13 20 27 7 14 21 28 8 15 22 29 9 16 23 30 10 17 24 31 11 18 25 12 19 26	WRZEŚIEŃ 35 36 37 38 39 40 2 9 16 23 30 3 10 17 24 31 4 11 18 25 5 12 19 26 6 13 20 27 7 14 21 28 8 15 22 29	PAŹDZIERNIK 46 41 42 43 44 1 8 15 22 29 2 9 16 23 30 3 10 17 24 31 4 11 18 25 5 12 19 26 6 13 20 27 7 14 21 28	LISTOPAD 44 45 46 47 48 4 11 18 25 5 12 19 26 6 13 20 27 7 14 21 28 8 15 22 29 9 16 23 30 10 17 24 31



CALENDRIER / CALENDAR	502T	507T	INDEX / INDEX		perforation de cornières corner perforation
format / format	208 x 260 mm -A4	167 x 240 mm -B5	impression printed	découpe tabbed	
nombre de pages / pages	160	160			
papier blanc / white paper impression / print	gris et bordeaux grey-maroon	✓	✓	✓	✓
	gris et bleu marine grey-dark blue	✓	✓	✓	✓
	gris et graphite grey-graphite				
papier chamois / ivory paper impression / print	gris et bordeaux grey-maroon	✓	✓	✓	✓
	gris et bleu marine grey-dark blue	✓	✓	✓	✓
	gris et graphite grey-graphite				
papier recyclé / recycled paper impression / print	gris et graphite grey-graphite				
papier d'herbes / grass paper impression / print	gris et graphite grey-graphite		✓	✓	
papier de pierre / stone paper impression / print	gris et graphite grey-graphite				
langue / language	GB DE IT UA				
données personnelles / personal data	✓	✓			
compteur de jours / day counter	✓	✓			
numérotation des semaines / week numbering	✓	✓			
fiche de planification des objectifs / goal planning sheet	✓	✓			
fêtes internationales / international holidays	✓	✓			
calendrier succinct / shortened calendar 2023-2025	✓	✓			
agenda annuel / annual planner	✓	✓			
agenda mensuel / monthly planner	✓	✓			
calendrier annuel / annual calendar 2024	✓	✓			
jour du prénom / name day	✓	✓			
aphorismes / aphorisms	✓	✓			
déclaration routière / accident statement	✓	✓			
carnet / notebook	✓	✓			
cartes / maps					

504T



CALENDRIER / CALENDAR		504T	INDEX / INDEX		perforation de cornières / corner perforation
format / format		84 x 151 mm format de poche pocket-sized format	impression printed	découpe tabbed	
nombre de pages / pages		128			
papier blanc / white paper impression / print	gris et bordeaux grey-maroon				
	gris et bleu marine grey-dark blue				
	gris et graphite grey-graphite	✓	✓		
papier chamois / ivory paper impression / print	gris et bordeaux grey-maroon				
	gris et bleu marine grey-dark blue				
	gris et graphite grey-graphite	✓	✓		
papier recyclé / recycled paper impression / print	gris et graphite grey-graphite				
papier d'herbes / grass paper impression / print	gris et graphite grey-graphite				
papier de pierre / stone paper impression / print	gris et graphite grey-graphite				
langue / language		GB DE IT UA			
données personnelles / personal data		✓			
compteur de jours / day counter					
numérotation des semaines / week numbering		✓			
fiche de planification des objectifs / goal planning sheet					
fêtes internationales / international holidays		✓			
calendrier succinct / shortened calendar 2023-2025		✓			
agenda annuel / annual planner					
agenda mensuel / monthly planner					
calendrier annuel / annual calendar 2024					
jour du prénom / name day		✓			
aphorismes / aphorisms					
relevé de route / accident statement					
carnet / notebook		✓			
cartes / maps					

505T

LUTY February, Februar, Febbraio, Люты							Tydzień 6 Week, Woche, Settimana, Тижень																					
5	Poniedziałek Mo / Me / Lu / Fr	36+330	6	Wtorek Tu / Di / We / Fr	37+329	7	Środa We / Mi / Me / Co	38+328	8	Czwartek Th / Do / Gi / Fr	39+327	9	Piątek Fr / Pi / We / Th	40+326	10	Sobota Sa / So / Sa / Co	41+325	11	Niedziela Su / So / Do / Ho	42+324								
Agata, Arkady			Doroce, Tytus			Pawła, Romuald			TŁUSTY CZWARTEK Jana, Piotr			Czesław, Antoni			OSTATNIA SOBOTA KARNAWAŁU Jana, Schyłek			Lazarz, Bernardy										
7	7		7	7		7	7		7	7		7	7		7	7		7	7									
8	8		8	8		8	8		8	8		8	8		8	8		8	8									
9	9		9	9		9	9		9	9		9	9		9	9		9	9									
10	10		10	10		10	10		10	10		10	10		10	10		10	10									
11	11		11	11		11	11		11	11		11	11		11	11		11	11									
12	12		12	12		12	12		12	12		12	12		12	12		12	12									
13	13		13	13		13	13		13	13		13	13		13	13		13	13									
14	14		14	14		14	14		14	14		14	14		14	14		14	14									
15	15		15	15		15	15		15	15		15	15		15	15		15	15									
16	16		16	16		16	16		16	16		16	16		16	16		16	16									
1	2	3	4	5	6	7	8	9	10	11	12	13	14	15	16	17	18	19	20	21	22	23	24	25	26	27	28	29



CALENDRIER / CALENDAR		505T	INDEX / INDEX		perforation de cornières corner perforation
format / format		297 x 105 mm de bureau desk	impression printed	découpe tabbed	
nombre de pages / pages		128			
papier blanc / white paper impression / print	gris et bordeaux grey-maroon				
	gris et bleu marine grey-dark blue				
	gris et graphite grey-graphite	✓			
papier chamois/ ivory paper impression / print	gris et bordeaux grey-maroon				
	gris et bleu marine grey-dark blue				
	gris et graphite grey-graphite	✓			
papier recyclé / recycled paper impression / print	gris et graphite grey-graphite				
papier d'herbes / grass paper impression / print	gris et graphite grey-graphite				
papier de pierre / stone paper impression / print	gris et graphite grey-graphite				
langue / language		GB DE IT UA			
données personnelles / personal data		✓			
compteur de jours / day counter		✓			
numérotation des semaines / week numbering		✓			
fiche de planification des objectifs / goal planning sheet					
fêtes internationales / international holidays		✓			
calendrier succinct / shortened calendar 2023-2025		✓			
agenda annuel / annual planner					
agenda mensuel / monthly planner					
calendrier annuel / annual calendar 2024					
jour du prénom / name day		✓			
aphorismes / aphorisms					
relevé de route / accident statement					
carnet / notebook		✓			
cartes / maps					

509T 511T 512T

LIPIEC		Tydzień 30	
Jul. Juli, Luglio, Липень		Week, Woche, Settimana, Тижень	
22	Poniedziałek Mo / Mo / Lu / Pl	_____	
	Magdalena Ecksteinowa	_____	
23	Wtorek Tu / Di / Ma / Br	_____	
	Bogny Apollinariego	_____	
24	Środa We / Mi / Me / Cp	_____	
	King Krzysztof	_____	
25	Czwartek Th / Do / Gi / Fr	_____	
	Jakuba Krzysztofa	_____	
26	Piątek Fr / Ft / We / Tr	_____	
	Anny Miroslawy	_____	
27	Sobota Sa / Sa / Sa / C6	28	Niedziela Su / So / Do / H6
	Juli Natali		Wiktora Innocentego
<small>Wielkich rzeczy w biznesie nigdy nie robi jedna osoba. Robi je zespół ludzi. Steve Jobs</small>			



CALENDRIER / CALENDAR	509T	511T	512T	INDEX / INDEX		perforation de cornières corner perforation
format / format	149 × 203 mm ~A5	208 × 260 mm ~A4	167 × 240 mm ~B5	impression printed	découpe tabbed	
nombre de pages / pages	160	160	160			
papier blanc / white paper impression / print	gris et bordeaux grey-maroon					
	gris et bleu marine grey-dark blue					
	gris et graphite grey-graphwhite	✓	✓	✓		
papier chamois / ivory paper impression / print	gris et bordeaux grey-maroon					
	gris et bleu marine grey-dark blue					
	gris et graphite grey-graphite	✓		✓		
papier recyclé / recycled paper impression / print	gris et graphite grey-graphite	✓		✓		
papier d'herbes / grass paper impression / print	gris et graphite grey-graphite	✓	✓	✓		
papier de pierre / stone paper impression / print	gris et graphite grey-graphite	✓	✓	✓		
langue / language	GB DE IT UA					
données personnelles / personal data	✓	✓	✓			
compteur de jours / day counter						
numérotation des semaines / week numbering	✓	✓	✓			
fiche de planification des objectifs / goal planning sheet	✓	✓	✓			
fêtes internationales / international holidays	✓	✓	✓			
calendrier succinct / shortened calendar 2023-2025	✓	✓	✓			
agenda annuel / annual planner	✓	✓	✓			
agenda mensuel / monthly planner	✓	✓	✓			
calendrier annuel / annual calendar 2024						
jour du prénom / name day	✓	✓	✓			
aphorismes / aphorisms	✓	✓	✓			
relevé de route / accident statement	✓	✓	✓			
carnet / notebook	✓	✓	✓			
cartes / maps						

514T

FEBRUARY		Week 7
12	Monday	
13	Tuesday	
14	Wednesday	
15	Thursday	
16	Friday	
17	Saturday	18 Sunday



CALENDRIER / CALENDAR		514T	INDEX / INDEX		perforation de cornières / corner perforation
format / format		167 x 240 mm -B5	impression printed	découpe tabbed	
nombre de pages / pages		160			
papier blanc / white paper impression / print	gris et bordeaux / grey-maroon				
	gris et bleu marine / grey-dark blue				
	gris et graphite / grey-graphite	✓			
papier chamois / ivory paper impression / print	gris et bordeaux / grey-maroon				
	gris et bleu marine / grey-dark blue				
	gris et graphite / grey-graphite				
papier recyclé / recycled paper impression / print	gris et graphite / grey-graphite				
papier d'herbes / grass paper impression / print	gris et graphite / grey-graphite				
papier de pierre / stone paper impression / print	gris et graphite / grey-graphite				
langue / language		GB			
données personnelles / personal data		✓			
compteur de jours / day counter					
numérotation des semaines / week numbering		✓			
fiche de planification des objectifs / goal planning sheet		✓			
fêtes internationales / international holidays		✓			
calendrier succinct / shortened calendar 2023-2025		✓			
agenda annuel / annual planner		✓			
agenda mensuel / monthly planner		✓			
calendrier annuel / annual calendar 2024					
jour du prénom / name day					
aphorismes / aphorisms					
relevé de route / accident statement					
carnet / notebook		✓			
cartes / maps					

516 167 × 240 mm



stonebook[®]



CALENDRIER / CALENDAR		516	INDEX / INDEX		perforation de cornières / corner perforation
format / format		167 × 240 mm -B5	impression printed	découpe tabbed	
nombre de pages / pages		160			
papier blanc / white paper impression / print	gris et bordeaux / grey-maroon				
	gris et bleu marine / grey-dark blue				
	gris et graphite / grey-graphite	✓			
papier chamois / ivory paper impression / print	gris et bordeaux / grey-maroon				
	gris et bleu marine / grey-dark blue				
	gris et graphite / grey-graphite				
papier recyclé / recycled paper impression / print	gris et graphite / grey-graphite				
papier d'herbes / grass paper impression / print	gris et graphite / grey-graphite				
papier de pierre / stone paper impression / print	gris et graphite / grey-graphite	✓			
langue / language		GB			
données personnelles / personal data		✓			
compteur de jours / day counter					
numérotation des semaines / week numbering					
fiche de planification des objectifs / goal planning sheet					
fêtes internationales / international holidays					
calendrier succinct / shortened calendar 2023-2025					
agenda annuel / annual planner		✓			
agenda mensuel / monthly planner					
calendrier annuel / annual calendar 2024		✓			
jour du prénom / name day					
aphorismes / aphorisms					
relevé de route / accident statement					
carnet / notebook		✓			
cartes / maps					

CARNETS / NOTEBOOKS LAYOUTS

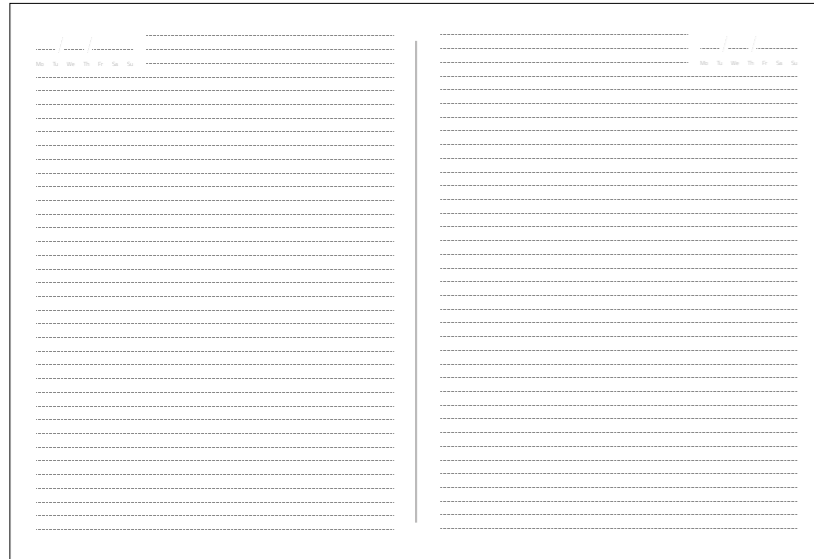

LIGNE / LINE

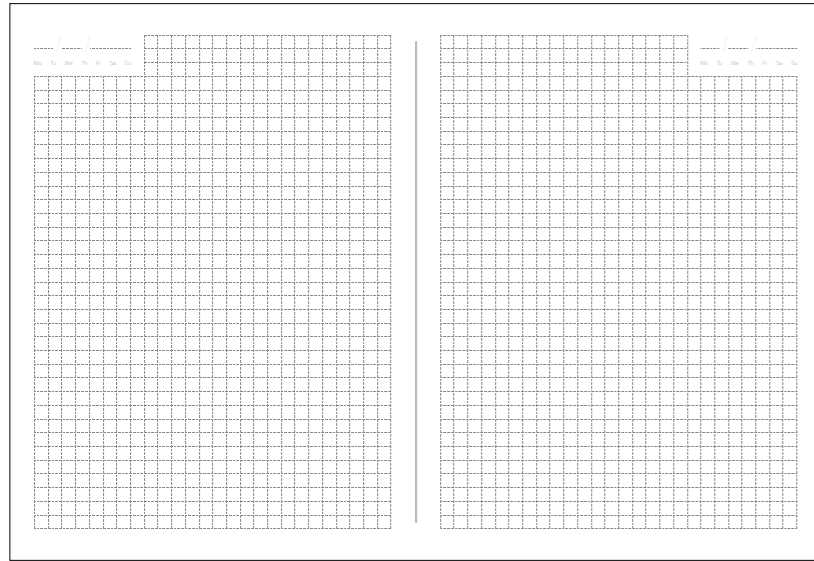

CARREAUX / SQUARED

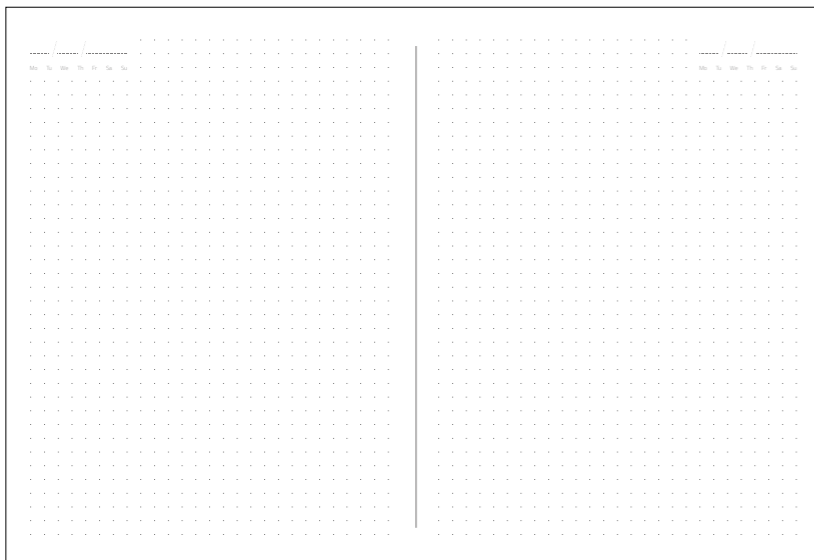

POINTS / DOTS

CARNET / NOTEBOOK			~A6	~A5	~B5	~A4
format / format			105 × 140 mm	130 × 208 mm	167 × 240 mm	208 × 260 mm
nombre de pages / pages			192	192	192	192
papier blanc / white paper impression / print	graphite / graphite	ligne / line	✓	✓	✓	
		carreaux / squared	✓	✓	✓	✓
		points / dots		✓		
		page blanche / plain	✓	✓		
papier chamois / ivory paper impression / print	graphite / graphite	ligne / line		✓		
		carreaux / squared		✓		
		points / dots				
		page blanche / plain				
perforation verticale et horizontale sur 16 dernières pages / vertical and horizontal perforation of last 16 pages				✓	✓	✓

nombre de pages / pages				192	192	
papier recyclé / recycled paper impression / print	graphite / graphite	ligne / line				
		carreaux / squared				
		points / dots		✓	✓	
		page blanche / plain				
perforation verticale et horizontale sur 16 dernières pages / vertical and horizontal perforation of last 16 pages						

nombre de pages / pages				144	144	
papier d'herbes / grass paper impression / print	graphite / graphite	ligne / line				
		carreaux / squared		✓	✓	
		points / dots				
		page blanche / plain				
perforation verticale et horizontale sur 16 dernières pages / vertical and horizontal perforation of last 16 pages						

nombre de pages / pages				144	144	
papier de pierre / stone paper impression / print	graphite / graphite	ligne / line		✓	✓	
		carreaux / squared		✓	✓	
		points / dots		✓		
		page blanche / plain		✓		
perforation verticale et horizontale sur 16 dernières pages / vertical and horizontal perforation of last 16 pages						

langue de dateur / date stamp language	GB NE CONCERNE PAS LES CARNETS À PAGES BLANCHES / DOES NOT APPLY TO PLAIN NOTEBOOKS				
--	--	--	--	--	--

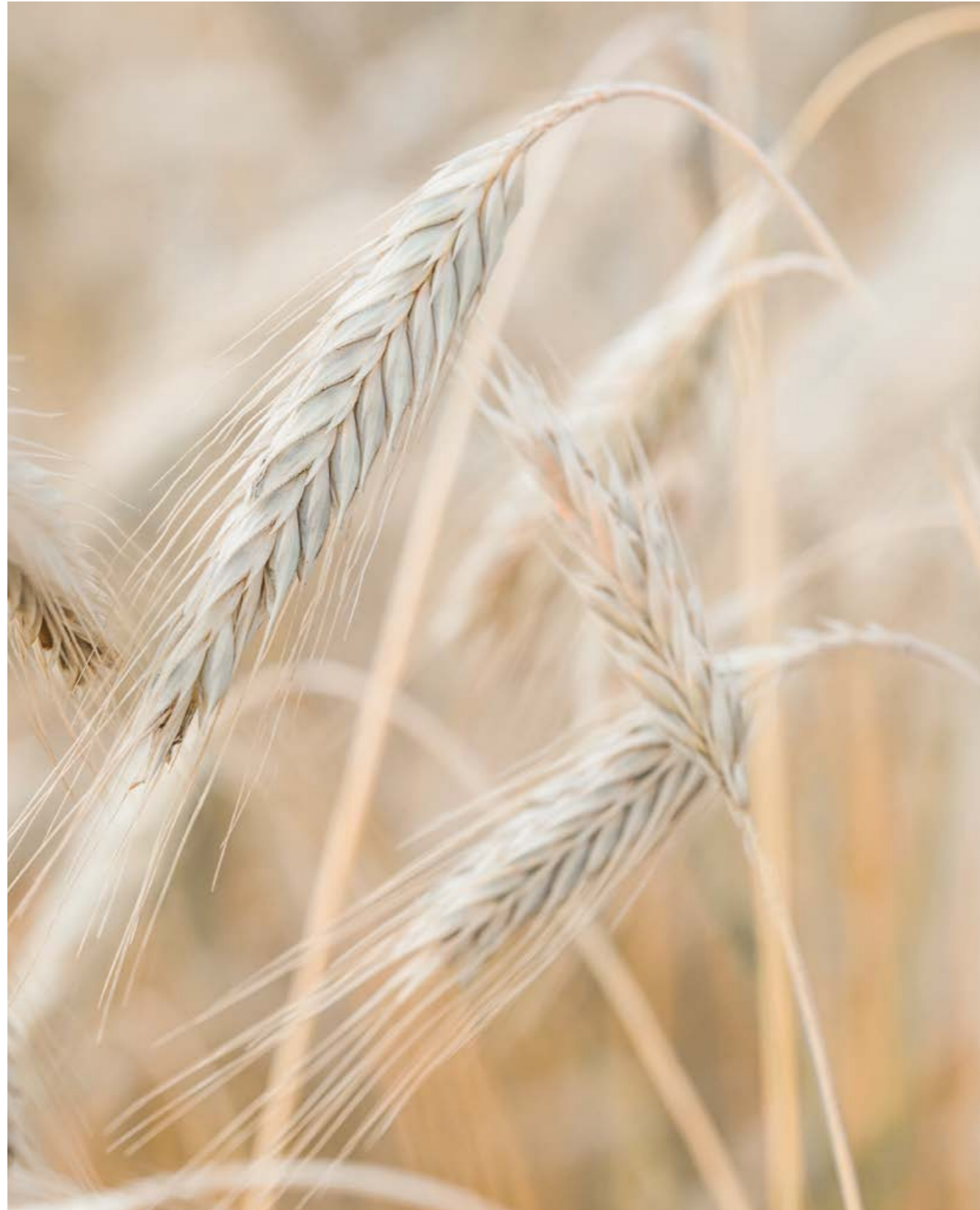

GADGETS FABRIQUÉS DANS LE RESPECT DE L'ENVIRONNEMENT À PARTIR DE PAILLE DE BLÉ COMBINÉE À DE L'ABS. / GADGETS MADE WITH CARE FOR THE ENVIRONMENT MADE OF WHEAT STRAW TOGETHER WITH ABS.

**GADGETS
CONÇUS
À PARTIR
DE BLÉ**

GADGETS
MADE OUT
OF WHEAT



BLÉ · BÉTON ET BAMBOU WHEAT · CEMENT AND BAMBOO

COMPOSEZ VOTRE PROPRE ECO SET / COMPOSE YOUR OWN ECO SET



HAUT-PARLEUR BLUETOOTH / BLUETOOTH SPEAKER
paille de blé + ABS / wheat straw + ABS

G0009 numéro de catalogue / catalogue number

- bluetooth / bluetooth: V 5.0
- haut-parleur / speaker: 3 W
- batterie / battery: 300 mAh
- microphone: appel mains libres / microphone: hands free calling
- dimension / size: 87 × 72 × 40 mm
- méthode de marquage: impression UV / marking method: UV printing



POWER BANK / POWERBANK
paille de blé + ABS / wheat straw + ABS

G0008 numéro de catalogue / catalogue number

- batterie / battery: 5000 mAh
- câble / cable: micro USB
- entrée / input: DC5V-2.0 A
- sortie / output: DC5V-2.0 A
- dimension / size: 94 × 63 × 14 mm
- méthode de marquage: impression UV / marking method: UV printing



CHARGEUR INDUCTION / WIRELESS CHARGER
paille de blé + ABS / wheat straw + ABS

G0012 numéro de catalogue / catalogue number

- entrée / input: DC5V-2.0 A
- sortie sans câble / wireless output: 5 W
- HUB 2 × USB
- dimension / size: 90 × 90 × 9 mm
- méthode de marquage: impression UV / marking method: UV printing



CÂBLE DE CHARGE USB LONG /
LONG USB CHARGING CABLE **NEW**
paille de blé + ABS / wheat straw + ABS

- connecteurs / connectors:
entrée / input USB A/C
sortie / output USB Micro/C, Lightning (iPhone)
- dimension / size: 1185 × 34 × 9 mm
- méthode de marquage:
impression UV (deux faces) /
marking method: UV print (on both sides)
- emballage / packaging**

G0011 numéro de catalogue / catalogue number

- insertion / insert: blé / wheat



CÂBLE DE CHARGE USB LONG /
LONG USB CHARGING CABLE **NEW**
paille de blé + ABS / wheat straw + ABS

- connecteurs / connectors:
entrée / input USB A/C
sortie / output USB Micro/C, Lightning (iPhone)
- dimension / size: 1185 × 34 × 9 mm
- méthode de marquage: gravure (une face) /
marking method: engraving (one side only)
- emballage / packaging**

G0029 numéro de catalogue / catalogue number

- insert / insert: blanche / white
- lumière / light: 00 - blanche / white



CÂBLE DE CHARGE USB LONG /
LONG USB CHARGING CABLE **NEW**
paille de blé + ABS+ bambou /
wheat straw + ABS + bamboo

- connecteurs / connectors:
entrée / input USB A/C
sortie / output USB Micro/C, Lightning (iPhone)
- dimension / size: 1185 × 34 × 9 mm
- méthode de marquage: impression UV (une face) /
marking method: UV print (one side only)
- emballage / packaging**

G0030 numéro de catalogue / catalogue number

- insert / insert: bambou / bamboo

*EMBALLAGES DISPONIBLES PP. 118-119. / AVAILABLE PACKAGING PP. 118-119.

**EMBALLAGE STANDARD POUR LES CÂBLES DE CHARGE ECO P. 108. / STANDARD PACKAGING FOR THE ECO CHARGING CABLE PAGE 108.



CÂBLE DE CHARGE USB LONG / LONG USB CHARGING CABLE ^{NEW}
bambou + ABS / bamboo + ABS*

- connecteurs / connectors: entrée / input USB A/C sortie / output USB C, Lightning (iPhone)
- dimension / size: 1220 x 35 x 10 mm
- méthode de marquage: gravure (une face) / marking method: engraving (one side only)
- emballage / packaging**

G0031 numéro de catalogue / catalogue number

- insert / insert: noir / black
- lumière / light: **00** - blanche / white

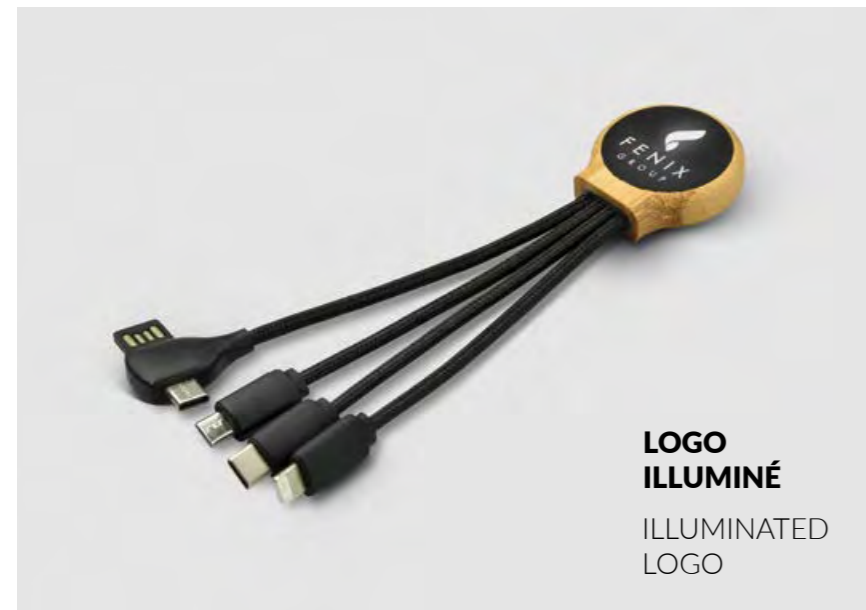

CÂBLE DE CHARGE USB COURT / SHORT USB CHARGING CABLE ^{NEW}
bambou + ABS / bamboo + ABS*

- connecteurs / connectors: entrée / input USB A/C sortie / output USB Micro/C, Lightning (iPhone)
- dimension / size: 162 x 37 x 10 mm
- méthode de marquage: gravure (une face) / marking method: engraving (one side only)
- emballage / packaging**

G0032 numéro de catalogue / catalogue number

- insert / insert: noir / black
- lumière / light: **00** - blanche / white



EMBALLAGE STANDARD / STANDARD PACKAGING



CHARGEUR INDUCTION DEBOUT / STAND WIRELESS CHARGER
ciment+ bambou / cement + bamboo

G0015 numéro de catalogue / catalogue number

- entrée / input: DV5V-2 A
- sortie sans câble / wireless output: 5 W
- dimension / size: 124 x 98 x 98 mm
- méthode de marquage: impression UV / marking method: UV printing



CHARGEUR INDUCTION / WIRELESS CHARGER ^{NEW}
bambou + rPET / bamboo + rPET

G0065 numéro de catalogue / catalogue number

- entrée / input: DC 9V/2A, 12V/1.5A, 5V/2A,
- connecteurs / connectors: entrée / input USB A/C
- sortie sans câble / wireless output: 15 W
- dimension / size: 130 x 65 x 10 mm
- méthode de marquage: impression UV / marking method: UV printing



CHARGEUR INDUCTION DEBOUT / STAND WIRELESS CHARGER ^{NEW}
bambou + rPET / bamboo + rPET

G0066 numéro de catalogue / catalogue number

- entrée / input: DC 9V/2A, 12V/1.5A, 5V/2A,
- connecteurs / connectors: entrée / input USB A/C
- sortie sans câble / wireless output: 15 W
- dimension / size: 155 x 100 x 10 mm
- méthode de marquage: impression UV / marking method: UV printing

*EMBALLAGES DISPONIBLES PP. 118-119. / AVAILABLE PACKAGING PP. 118-119.

**EMBALLAGE STANDARD POUR LES CÂBLES DE CHARGE ECO P. 108. / STANDARD PACKAGING FOR THE ECO CHARGING CABLE PAGE 108.



ECO BOX 3

CHARGEUR INDUCTION G0012 +
POWER BANK G0008 / WIRELESS CHARGER
G0012 + POWERBANK G0008



ECO BOX 7 NEW

POWER BANK G0008 + CÂBLE DE CHARGE USB
LONG G0029 / POWERBANK G0008 + LONG USB
CHARGING CABLE G0029



ECO BOX 4

POWER BANK G0008 + HAUT-PARLEUR USB
LONG G0009 / POWERBANK G0008 + BLUETOOTH
SPEAKER G0009



ECO BOX 8 NEW

POWERBANK G0008 + HAUT-PARLEUR USB LONG
G0011 / POWERBANK G0008 + LONG USB
CHARGING CABLE G0011



ECO BOX 5

CHARGEUR INDUCTION G0012 +
HAUT-PARLEUR BLUETOOTH G0009 /
WIRELESS CHARGER G0012 +
BLUETOOTH SPEAKER G0009



ECO BOX 9 NEW

HAUT-PARLEUR BLUETOOTH G0009 + CÂBLE DE
CHARGE USB LONG G0011 / BLUETOOTH SPEAKER
G0009 + LONG USB CHARGING CABLE G0011



POWER SET KRAFT 1 NEW

POWER BANK G0008 + CÂBLE DE CHARGE USB LONG G0011 / POWERBANK G0008 + LONG USB CHARGING CABLE G0011



POWER SET KRAFT 2 NEW

POWER BANK G0008 + CÂBLE DE CHARGE USB LONG G0029 / POWERBANK G0008 + LONG USB CHARGING CABLE G0029



POWER SET KRAFT 3 NEW

POWER BANK G0008 + CÂBLE DE CHARGE USB LONG G0030 / POWERBANK G0008 + LONG USB CHARGING CABLE G0030



ECO SET 3

CARNET A5+ CHARGEUR INDUCTION G0012 + POWER BANK G0008 / A5 NOTEBOOK + WIRELESS CHARGER G0012 + POWERBANK G0008



ECO SET 4

CARNET A5+ POWER BANK G0008 + HAUT-PARLEUR BLUETOOTH G0009 / A5 NOTEBOOK + POWERBANK G0008 + BLUETOOTH SPEAKER G0009



ECO SET 5

CARNET A5 + CHARGEUR INDUCTION G0012 + HAUT-PARLEUR BLUETOOTH G0009 / A5 NOTEBOOK + WIRELESS CHARGER G0012 + BLUETOOTH SPEAKER G0009

ECO SET 7

CARNET A5+ CHARGEUR INDUCTION
G0015 / A5 NOTEBOOK + WIRELESS
CHARGER G0015



ECO SET 9 NEW

CARNET A5 + CÂBLE DE CHARGE USB LONG G0031 +
STYLO G0073 / A5 NOTEBOOK + LONG USB CHARGING
CABLE G0031 + PEN G0073



ECO SET 8 NEW

CARNET A5+ CHARGEUR INDUCTION
DEBOUT G0066 / A5 NOTEBOOK +
STAND WIRELESS CHARGER G0066



CÂBLE DE CHARGE USB / USB CHARGING CABLES



LOGO ILLUMINÉ
ILLUMINATED LOGO

CÂBLE DE CHARGE USB COURT / SHORT USB CHARGING CABLE

- quatre ports conformes avec / four connectors compatible with: USB, Micro USB, USB C, Lightning (iPhone)
- dimension / size: 160 × 35 × 10 mm
- méthode de marquage: gravure (deux faces) / marking method: engraving (on both sides)

G0026 numéro de catalogue / catalogue number

- couleur / colour: bleu marine / navy blue
- lumière / light: 00 - blanche / white

G0027 numéro de catalogue / catalogue number

- couleur / colour: rouge / red
- lumière / light: 00 - blanche / white



IMPRESSION UV AVEC ÉLÉMENTS RÉTROÉCLAIRÉS
UV PRINT WITH ILLUMINATED ELEMENTS



LOGO ILLUMINÉ
ILLUMINATED LOGO



LOGO ILLUMINÉ
ILLUMINATED LOGO



LOGO ILLUMINÉ
ILLUMINATED LOGO



LOGO ILLUMINÉ
ILLUMINATED LOGO

CÂBLE DE CHARGE USB COURT / SHORT USB CHARGING CABLE

- connecteurs / connectors: entrées / input USB A/C, sortie / output USB Micro/C, Lightning (iPhone)
- dimension / size: 153 × 35 × 10 mm
- méthode de marquage / marking method: gravure (deux faces) / engraving (on both sides) - **G0067, G0068**
impression UV (deux faces) / UV print (on both sides) - **G0067**

G0067 numéro de catalogue / catalogue number

- couleur / colour: blanc / white
- lumière / light: 00 - blanche / white, 02 - rouge / red, 03 - orange / orange

G0068 numéro de catalogue / catalogue number

- couleur / colour: noir / black
- lumière / light: 00 - blanche / white, 02 - rouge / red, 07 - bleue / blue

CÂBLE DE CHARGE USB LONG / LONG USB CHARGING CABLE

- connecteurs / connectors: entrée / input USB A/C, sortie / output USB Micro/C, Lightning (iPhone)
- dimension / size: 1205 × 34 × 9 mm
- méthode de marquage / marking method: gravure (une face) / engraving (one side only) - **G0069, G0070**
impression UV (une face) / UV print (one side only) - **G0069**

G0069 numéro de catalogue / catalogue number

- couleur / colour: blanche / white
- lumière / light: 00 - blanche / white

G0070 numéro de catalogue / catalogue number

- couleur / colour: noir / black
- lumière / light: 00 - blanche / white

CÂBLE DE CHARGE USB / USB CHARGING CABLES

EMBALLAGE POUR CÂBLES DE CHARGE / PACKAGING FOR USB CHARGING CABLES

FEUILLE AVEC CARTON IMPRIMÉ DEUX FACES SELON LA CONCEPTION PERSONNALISÉE
FOIL WITH PRINTED CARDBOARD ON BOTH SIDES ACCORDING TO CUSTOMISED DESIGN

- dimension (câble de charge court) / size (short charging cable): 198 × 70 mm
- dimension (câble de charge long) / size (long charging cable): 230 × 70 mm



PAPIER TEINT DANS LA MASSE / MASS DYED PAPER

- dimension (câble de charge court) / size (short charging cable): 180 × 53 × 16 mm
- dimension (câble de charge long) / size (long charging cable): 210 × 60 × 25 mm



EMBALLAGE POUR CÂBLES DE CHARGE COURT ET LONG AVEC IMPRESSION PACKAGING FOR SHORT AND LONG CHARGING CABLE WITH PRINT



PAPIER TEINT DANS LA MASSE OU CRAFT AVEC IMPRESSION NOIRE / MASS DYED PAPER OR KRAFT WITH BLACK PRINT **NEW**

- dimension (câble de charge court) / size (short charging cable): 180 × 60 × 20 mm
- dimension (câble de charge long) / size (long charging cable): 215 × 70 × 20 mm



POWER BANKS / POWERBANKS



POWER BANK / POWERBANK

G0003 numéro de catalogue / catalogue number

- couleur / colour: **01** – noir / black, **02** – rouge / red, **08** – bleu marine / navy blue
- capacité de batterie / battery capacity: **4000 mAh**
- niveau de charge en quatre étapes / four stage charging level
- durée de vie: env. 500 chargements / number of charging cycles: approx 500
- entrée / input: Micro USB
- sorties / output: USB × 2
- dimension / size: 138 × 66 × 9 mm
- méthode de marquage: gravure (une face) / marking method: engraving (one side only)

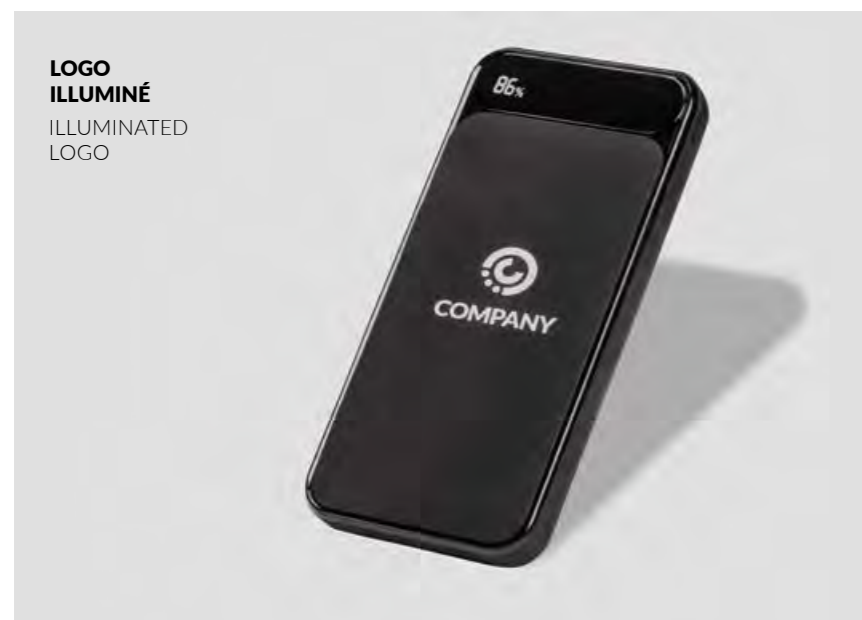

POWER BANK / POWERBANK **NEW**

G0074 numéro de catalogue / catalogue number

- couleur / colour: **01** – noir / black
- capacité de batterie / battery capacity: **10 000 mAh**
- affichage numérique: pourcentage de la charge / digital display: charge percentage
- durée de vie: env. 500 chargements / number of charging cycles: approx 500
- entrée / input: Micro USB, USB C - DC5V/2A
- sorties / output: USB x2 - DC5V/2A (maks. 2,1A)
- dimension / size: 132,1 × 67 × 20,6 mm
- méthode de marquage: gravure (une face) / marking method: engraving (one side only)

ENERGY SET



ENERGY SET



CALENDRIER/CARNET + POWER BANK + CÂBLE DE CHARGEMENT USB COURT /
CALENDAR/NOTEBOOK + POWERBANK + SHORT USB CHARGING CABLE

couleur de set / set colour

calendrier ou carnet / calendar or notebook

emballage / packaging

marquage de l'emballage / marking method of the packaging

noir / black
bleu marine / navy blue
rouge / red

503D, 509T, 510D – calendrier / calendar
ou / or
A5 – carnet / notebook

papier teint dans la masse noir / black mass dyed paper

sérigraphie / silk-screen

POWER SET



POWER BANK + CÂBLE DE CHARGEMENT USB COURT / POWERBANK + SHORT USB CHARGING CABLE

couleur de set / set colour
 emballage / packaging
 marquage de l'emballage / marking method of the packaging

noir / black
 rouge / red
 bleu marine / navy blue
 noir / black **NEW**
 de couleur de set / in the set colour
 sérigraphie / silk-screen

POWER BANK + CÂBLE DE CHARGEMENT USB LONG / POWERBANK + LONG USB CHARGING CABLE

couleur de set / set colour
 emballage / packaging
 marquage de l'emballage / marking method of the packaging

noir / black
 de couleur de set / in the set colour
 sérigraphie / silk-screen

WHITE BOX & BLACK BOX



CARNET + CÂBLE DE CHARGEMENT USB STANDARD + BOITE À COUVERCLE DÉCO /
NOTEBOOK + USB CHARGING CABLE + DECORATIVE LID BOX

couleur de set / set colour

calendrier ou carnet / calendar or notebook

couleur de câble de charge / charger colour

emballage / packaging

noir / black
blanc / white

pour tout format hors calendrier 501D, 505T /
for any format except 501D, 505T calendar

blanc / white
noir / black

papier teint dans la masse noir / black mass dyed paper
carton blanc / white cardboard

LISTE DE BLOCS / LIST OF BLOCKS

CALENDRIER JOURNALIER / DAILY CALENDAR

BLOC BLOCK	NOMBRE DE PAGES NUMBER OF PAGES	FORMAT DE CARNET BLOCK FORMAT	PAPIER / PAPER				AGENDA MENSUEL MONTHLY PLANNER	PERFORATION CORNIÈRE CORNER PERFORATION	APHORISMES APHORISMS	INDEX / INDEX	
			BLANC WHITE	CHAMOIS IVORY	RÉCYCLÉ RECYCLED	IMPRESSION PRINT*				DÉCOUPE TABBED	IMPRESSION PRINTED
501D	368	200 × 280 mm	✓	✓		● ● ●	✓	✓	✓	✓	✓
503D	368	143 × 203 mm	✓	✓		● ● ●	✓	✓	✓	✓	✓
503D	368	143 × 203 mm			✓	● ●	✓		✓		✓
506D	368	110 × 160 mm	✓			● ●	✓		✓		✓
508D	368	162 × 240 mm	✓	✓		● ● ●	✓	✓	✓	✓	✓
510D	368	143 × 203 mm	✓			● ●	✓				✓

* ● ● / ● ● / ● ● couleur d'impression / print colour

CALENDRIER HEBDOMADAIRE / WEEKLY CALENDAR

BLOC BLOCK	NOMBRE DE PAGES NUMBER OF PAGES	FORMAT DE CARNET BLOCK FORMAT	PAPIER / PAPER					AGENDA MENSUEL MONTHLY PLANNER	PERFORATION CORNIÈRE CORNER PERFORATION	APHORISMES APHORISMS	INDEX / INDEX		
			BLANC WHITE	CHAMOIS IVORY	RÉCYCLÉ RECYCLED	D'HERBE GRASS	DE PIERRE STONE				IMPRESSION PRINT*	DÉCOUPE TABBED	IMPRESSION PRINTED
502T	160	208 × 260 mm	✓	✓					● ● ●	✓	✓	✓	✓
504T	128	84 × 151 mm	✓	✓					● ●				✓
505T	128	297 × 105 mm	✓	✓					● ●				
507T	160	167 × 240 mm	✓	✓					● ● ●	✓	✓	✓	✓
					✓			● ●		✓		✓	✓
509T	160	149 × 203 mm	✓	✓	✓	✓	✓	● ●		✓			
511T	160	208 × 260 mm	✓			✓	✓	● ●		✓	✓		
512T	160	167 × 240 mm	✓		✓	✓	✓	● ●		✓	✓		
514T	160	167 × 240 mm	✓					● ●		✓			

* ● ● / ● ● / ● ● couleur d'impression / print colour

CALENDRIER ANNUEL AVEC CARNETS / ANNUAL CALENDAR WITH NOTEBOOK

BLOC BLOCK	NOMBRE DE PAGES NUMBER OF PAGES	FORMAT DE CARNET BLOCK FORMAT	PAPIER / PAPER		
			BLANC WHITE	DE PIERRE STONE	IMPRESSION PRINT*
516	160	167 × 240 mm	✓	✓	● ●

* ● ● couleur d'impression / print colour

CARNET / NOTEBOOK

BLOC BLOCK	NOMBRE DE PAGES NUMBER OF PAGES	FORMAT DE CARNET BLOCK FORMAT	PAPIER / PAPER					PAGE BLANCHE PLAIN	LIGNE LINE	CARREAUX SQUARED	POINTS DOTS	PERFORATION PERFORATION**
			BLANC WHITE	CHAMOIS IVORY	RÉCYCLÉ RECYCLED	D'HERBE GRASS	DE PIERRE STONE					
A6	192	105 × 140 mm	✓					●	✓	✓	✓	
A5	192	130 × 208 mm	✓					●	✓	✓	✓	✓
	192	130 × 208 mm		✓				●		✓	✓	✓
	192	130 × 208 mm			✓			●			✓	
	144	130 × 208 mm				✓		●		✓		
	144	130 × 208 mm					✓	●	✓	✓	✓	
B5	192	167 × 240 mm	✓					●		✓		✓
	192	167 × 240 mm			✓			●			✓	
	144	167 × 240 mm				✓		●		✓		
	144	167 × 240 mm					✓	●	✓	✓		
A4	192	208 × 260 mm	✓					●		✓		✓

* ● couleur d'impression / print colour

** PERFORATION VERTICALE ET HORIZONTALE SUR 16 DERNIÈRES PAGES / VERTICAL AND HORIZONTAL PERFORATION OF LAST 16 PAGES

Compte tenu des limites de technique d'impression, les couleurs réelles de différents produits peuvent différer légèrement des celles représentées sur les images. Toutes les dimensions sont données à titre indicatif et ne peuvent donner lieu à une réclamation. Le fabricant se réserve le droit d'apporter des modifications techniques aux différents produits et n'est tenu responsable d'éventuelles erreurs d'impression. Toutes les marques publiées dans le catalogue constituent la propriété de leurs auteurs et sont présentées uniquement à titre indicatif. Le catalogue ne constitue pas une offre aux sens des dispositions du Code civil. Fabrication en Pologne. / Due to restrictions of printing techniques, actual colours may slightly vary from the ones presented in the catalogue. The sizes and formats provided are for reference only and cannot be the subject of complaint. The manufacturer reserves the right to technical modifications, as well as is not responsible for any possible printing errors. All the trademarks that appear in the catalogue are the property of their authors and are presented for reference only. The catalogue does not constitute an offer within the meaning of the Civil Code. Made in Poland.